

HyperRapid NX

The Benchmark for Industrial 24/7 Micromachining Applications

The HyperRapid NX high power industrial picosecond laser features a compact and modular design with a single customer interface for all power levels and wavelengths.

The outstanding wide window of operation enables optimum process performance under all circumstances: High average power levels deliver high throughput and minimize cost-per-part while flexibility in repetition rate and pulse energy results in excellent quality.

The HyperRapid NX product support strategy includes options to match the most demanding uptime and cost-of-ownership requirements.

FEATURES & BENEFITS

- Single wavelength output: 1064 nm, 532 nm, or 355 nm
- Unique combination of power and operational flexibility to reduce cost-per-part for micromachining applications
- SmartPulse™ for total pulse control to the user
- Many product support options to optimize uptime and cost-of-ownership
- Compact and light weight with common interfacing for all models for easy integration

APPLICATIONS

- Cutting and drilling of glass, sapphire, ceramics and other brittle materials and composites
- Cutting, drilling, selective removal of complex composite structures from dissimilar materials, including oxides, plastics, and organics
- Micromachining and structuring of large surfaces with line focusing or multiple beams



SPECIFICATIONS ^{1,2,3,4,5}	HyperRapid NX					
	1064-50	532-25	355-15	1064-100	532-50	355-30
Single Wavelength Output (nm)	1064	532	355	1064	532	355
Amplifier Pulse Repetition Rate (kHz)	200 to 1000			400 to 1000		
Output Pulse Repetition Rate Range (kHz)	0 to 1000					
Pulse Duration (ps)	<15					
Average Power (W)	50 ⁶	25	15	100	50	30
Average Power stability ⁷ (RMS 1 σ ,%)	≤1					
Pulse Energy (μJ)	220	125	75	250	125	75
Pulse-to-Pulse Energy Stability (RMS 1s, %) ≤	1	2	2	1	2	2
Beam Quality Parameter (M ²)	≤1.3					
Beam Diameter, 1 m in front of laser (mm)	5.0 ± 0.5					
Beam Divergence, full angle (mrad)	≤1					
Beam Circularity, 1 m in front of laser (%)	≥85					
Beam-Pointing Stability (μrad/°C)	≤50 (peak-to-peak)					
Bore Sight Accuracy (beam to specified exit location)						
Lateral	≤1 mm					
Angular	≤5 mrad					
Direction of Polarization (Vertical/Horizontal)	V	H	H	V	H	H
Polarization Ratio	>100:1					
Warm-up Time from Chiller Start (min)	<45					
Electrical Supply	100 to 230V AC/50 to 60 Hz/2.5 kW					
Mounting Orientation	Horizontal					
Chiller	Water-to-Air or Water-to-Water					
Dimensions						
Laser Head	600 x 780 x 245 mm					
Power Supply	3U 19" rack					
SMC Chiller	500 x 317 x 615 mm					
Weight						
Laser Head	≤67 kg					
Power Supply	16 kg					
SMC Chiller	43 kg					
BURST MODE OPERATION						
Burst Mode Operation Range (kHz)	100 to 1000					
Total Energy in the Burst ⁸ (μJ)	≥ 500	N/A	N/A	≥ 500	N/A	N/A
Maximum Number of Burst ⁹	10					
OPERATING SPECIFICATIONS						
Allowed Temperature Range During Operation	+15°C to +30°C (free of condensation)					
Humidity (%)	0 to 90 RH, non-condensing, Dew-point <22°C					

1 At lowest amplifier pulse repetition rate, unless stated otherwise.

2 Maximum output power (variable attenuator and process shutter at maximum transmission).

3 After warm-up time, chiller temperature = 23 ± 0.1°C.

4 Steady-state (no pulse gating or change of pulse repetition rate).

5 Single-pulse operation (burst number = 1).

6 At 500 kHz.

7 Over 8 hours, ±1°C ambient temperature.

8 With 5 pulses in the burst, at the lowest burst mode operation range frequency.

9 (Pulse repetition rate) x (number of burst) cannot exceed 5 MHz.

TYPICAL PERFORMANCE CHARTS

Typical Power Output

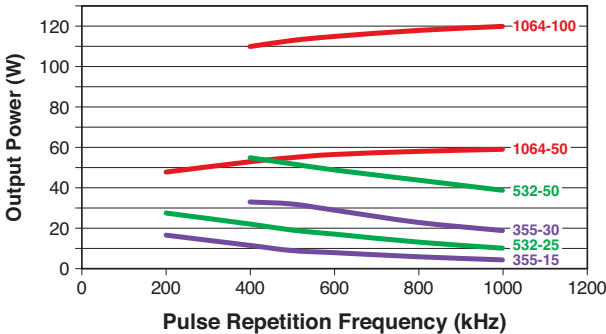

Typical Single Pulse Energy Output

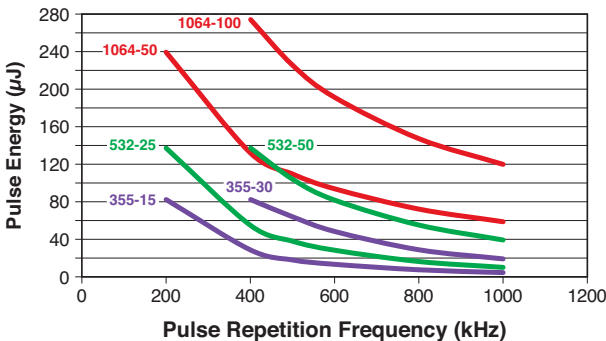

TYPICAL MANUFACTURING DATA FOR HyperRapid NX 355-30 (30 W UV)

HyperRapid NX is able to deliver cutting-edge performance in volume. Manufacturing data shows the excellent performance and reliable consistency across a large number of laser systems.

Average Power and Power Stability

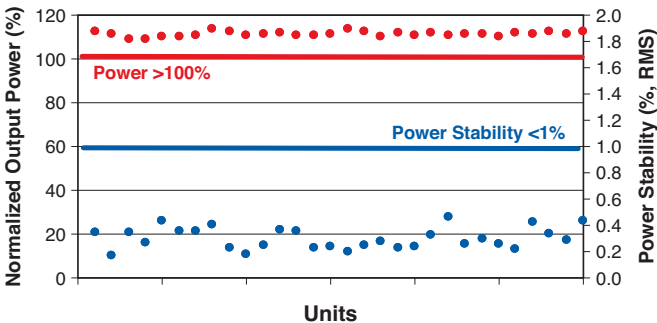

Beam Quality: M² and Beam Circularity

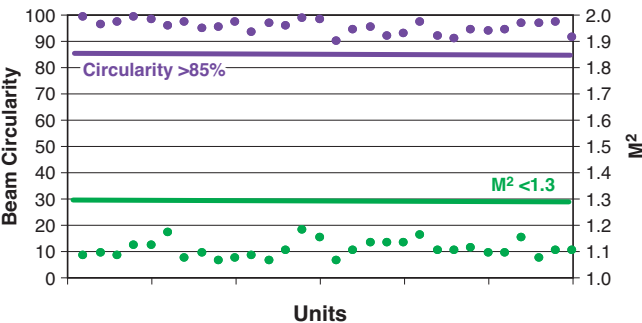

SmartPulse™: Placing You in the Driver’s Seat

HyperRapid NX architecture gives you full control on the pulse train delivered to the workpiece. You are able to fine tune your process to the greatest detail or address different applications with the same laser.

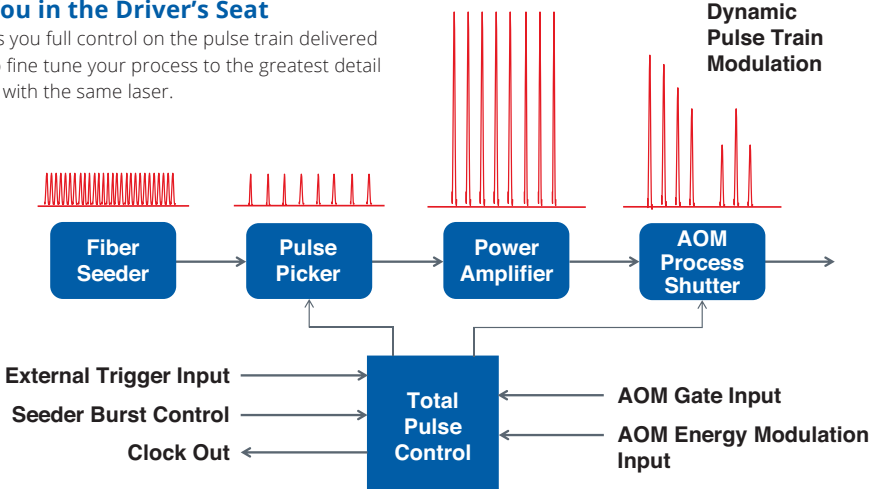

MECHANICAL SPECIFICATIONS

HyperRapid NX

Bottom View

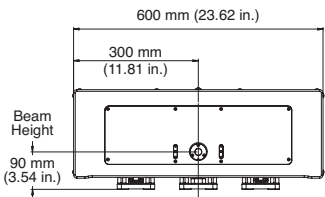
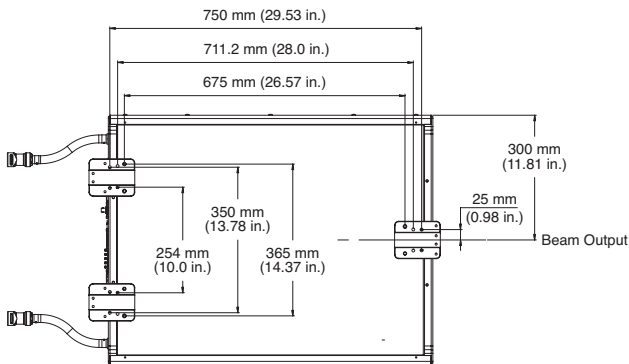

Front View

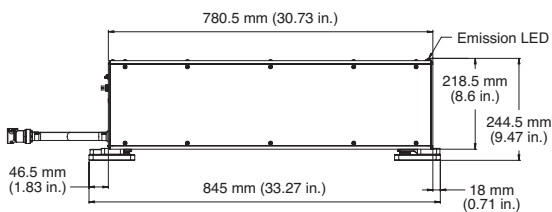

Side View

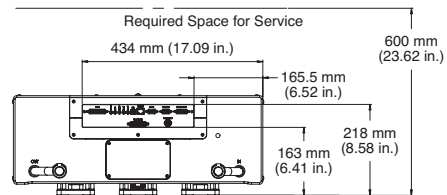

Rear View

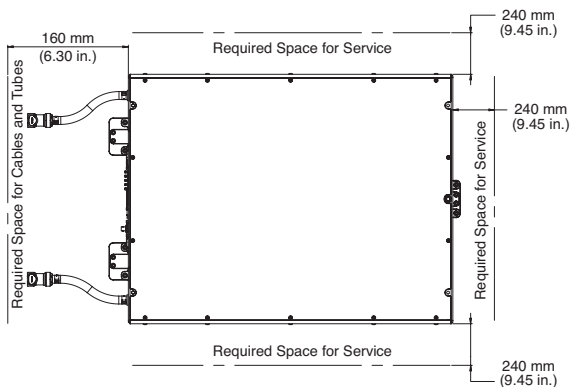

Top View



Coherent, Inc.,
 5100 Patrick Henry Drive Santa Clara, CA 95054
 p. (800) 527-3786 | (408) 764-4983
 f. (408) 764-4646

tech.sales@coherent.com www.coherent.com

Coherent follows a policy of continuous product improvement. Specifications are subject to change without notice.

Coherent offers a limited warranty for all HyperRapid NX Lasers. For full details of this warranty coverage, please refer to the Service section at www.coherent.com or contact your local Sales or Service Representative. MC-012-16-0M0718Rev.C Copyright ©2018 Coherent, Inc.

