

# HyperRapid NXT SmartCleave

## High-Speed and High-Quality Brittle Material Processing

HyperRapid NXT SmartCleave is an industrial high-power picosecond laser that is specifically optimized for high-speed and high-quality cutting of transparent and brittle materials. Using the Coherent patented SmartCleave technology, HyperRapid NXT delivers kerf-less cutting on arbitrarily curved outer or inner contours.

HyperRapid NXT SmartCleave features 1 millijoule burst energy to cut thick substrate in a single pass with sub-micron edge roughness, therefore enabling new applications in the automotive and consumer electronics markets.

The 50 W average power model is optimal for cost-sensitive applications, while the 100 W version enables high speed applications up to 2 m/s.

### FEATURES & BENEFITS

- 1064 nm output
- 100 W power to enable high throughput
- Over 1000  $\mu\text{J}$  burst energy to cut thicker samples
- Specified burst mode operation for repeatable performance in volume manufacturing
- Compact and light weight, same interfacing as standard HyperRapid NXT to allow straightforward integration
- Right of use to the Coherent SmartCleave IP is included

### APPLICATIONS

- Cutting of strengthened and unstrengthened glass, sapphire, and ceramics
- Scribing and drilling of glass, sapphire, ceramics, and composite materials



<b>OPTICAL SPECIFICATIONS</b> <sup>1,2,3,4,5</sup>	<b>HyperRapid NXT SmartCleave 1064-50</b>	<b>HyperRapid NXT SmartCleave 1064-100</b>
Single Wavelength Output (nm)	1064	
Amplifier Single Pulse Repetition Rate (kHz)	170 to 1000	400 to 1000
Output Pulse Repetition Rate Range (kHz)	0 to 4000	
Pulse Duration (ps)	<15	
Average Power (W)	50 <sup>6</sup>	100
Average Power Stability <sup>7</sup> (RMS 1 $\sigma$ , %)	$\leq 1$	
Pulse Energy ( $\mu$ J)	250	
Pulse-to-Pulse Energy Stability (RMS 1 $\sigma$ , %)	$\leq 1$	
Beam Quality Parameter (M <sup>2</sup> )	$\leq 1.3$	
Beam Diameter, 1 m in front of laser (mm)	5.0 $\pm$ 0.5	
Beam Divergence, full angle (mrad)	$\leq 1$	
Beam Circularity, 1 m in front of laser (%)	$\geq 85$	
Beam-Pointing Stability ( $\mu$ rad/ $^{\circ}$ C)	$\leq 50$ (peak-to-peak)	
Bore Sight Accuracy		
Lateral (mm) (beam to specified exit location)	$\leq 1$	
Angular (mrad) (beam to specified exit direction)	$\leq 5$	
Direction of Polarization	Vertical	
Polarization Ratio	>100:1	
Warm-up Time from Chiller Start (minutes)	<45	
Electrical Supply	100 to 230V AC/50 to 60 Hz/2.5 kW	
Mounting Orientation	Horizontal	
Chiller	Water-to-Air or Water-to-Water	
Dimensions		
Laser Head	600 x 780 x 245 mm (23.6 x 30.7 x 9.6 in.)	
Power Supply	3U 19" rack	
SMC Chiller	500 x 317 x 615 mm (19.7 x 12.5 x 24.2 in.)	
Weight		
Laser Head	70 kg (154.3 lbs.)	
Power Supply	16 kg (35.3 lbs.)	
SMC Chiller	43 kg (94.8 lbs.)	
<b>BURST MODE OPERATION</b>		
Maximum Number of Pulses in the Burst <sup>8</sup>	20	
Burst Mode Operation Range (kHz)	See table on next page	
Total Energy in the Burst ( $\mu$ J)	See table on next page	
<b>OPERATING SPECIFICATIONS</b>		
Allowed Temperature Range During Operation	+15 $^{\circ}$ C to +30 $^{\circ}$ C (free of condensation)	
Humidity (%)	0 to 90 RH, non-condensing, Dew-point <22 $^{\circ}$ C	

1 At lowest amplifier pulse repetition rate, unless stated otherwise.

2 Maximum output power (variable attenuator and process shutter at maximum transmission).

3 After warm-up time.

4 Steady-state (no pulse gating or change of pulse repetition rate).

5 Single-pulse operation.

6 At 500 kHz.

7 Over 8 hours,  $\pm 1^{\circ}$ C ambient temperature.

8 Maximum number of pulses in the burst depends on repetition rate.

## Specifications: HyperRapid NXT SmartCleave 1064-50

Number of Pulses in the Burst	Burst Energy <sup>1</sup> ( $\mu\text{J}$ )	Min. Rep. Rate (kHz)	Max. Eff. Rep. Rate (kHz)
2	400	110	2500
3	520	85	1600
4	600	75	1250
5	700	65	1000
6	750	60	830
7	830	55	710
8	875	55	620
9	925	50	550
10	1000	50	500

<sup>1</sup> Burst energy specification is given at the minimum repetition rate.

## Specifications: HyperRapid NXT SmartCleave 1064-100

Number of Pulses in the Burst	Burst Energy <sup>1</sup> ( $\mu\text{J}$ )	Min. Rep. Rate (kHz)	Max. Eff. Rep. Rate (kHz)
2	400	240	2500
3	520	185	1600
4	600	155	1250
5	700	135	1000
6	750	125	830
7	830	115	710
8	875	105	620
9	925	100	550
10	1000	95	500

<sup>1</sup> Burst energy specification is given at the minimum repetition rate.

## HyperRapid NXT SmartCleave 1064-50

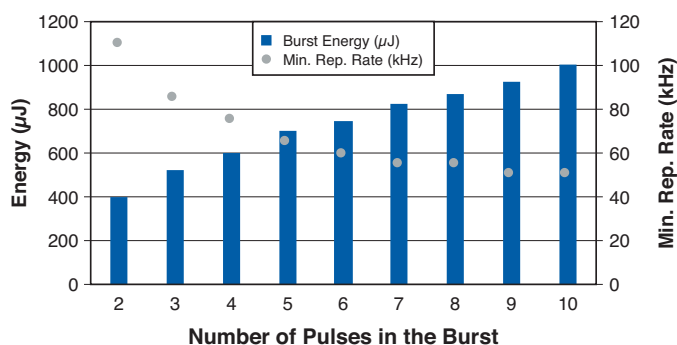

## HyperRapid NXT SmartCleave 1064-100

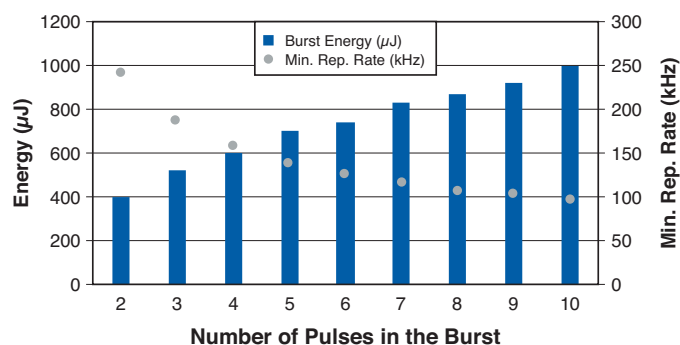

### HyperRapid NXT SmartCleave Burst Mode Operation

Oscilloscope trace showing 5 pulses in the burst at 100 kHz repetition rate. The pulses in the burst are separated by 25 ns

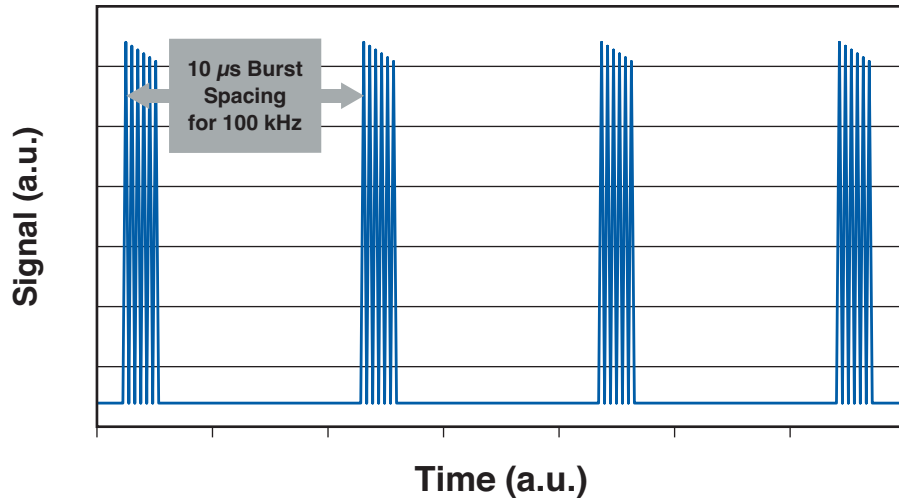

### HyperRapid NXT SmartCleave Applications

Typical industrial applications served by HyperRapid NX SmartCleave: glass cutting (left), automotive dashboard cutting (right)



**MECHANICAL SPECIFICATIONS**

**HyperRapid NXT SmartCleave**

**Bottom View**

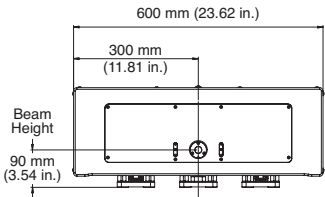
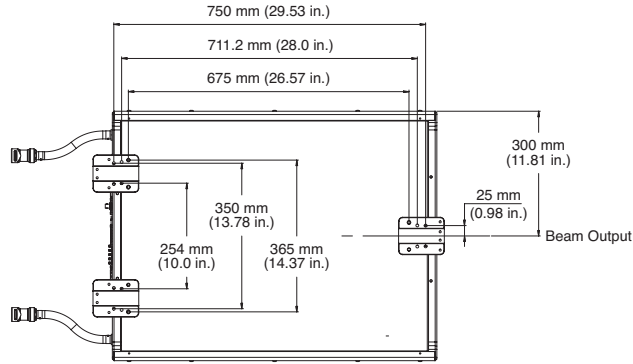

**Front View**

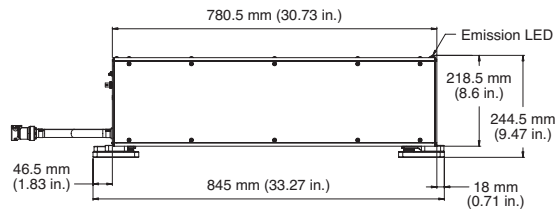

**Side View**

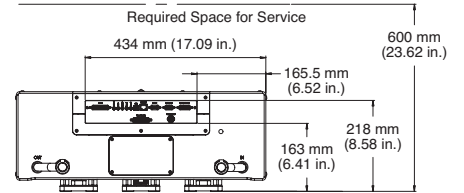

**Rear View**

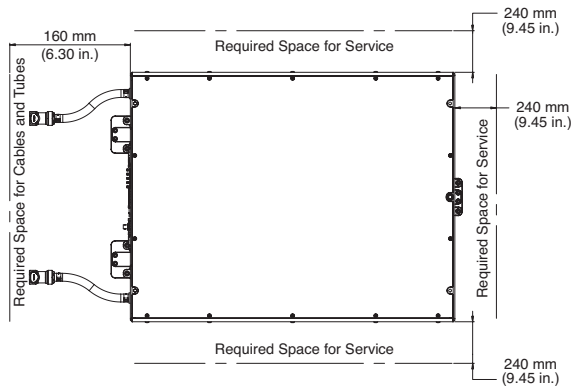

**Top View**



Coherent, Inc.,  
 5100 Patrick Henry Drive Santa Clara, CA 95054  
 p. (800) 527-3786 | (408) 764-4983  
 f. (408) 764-4646

[tech.sales@coherent.com](mailto:tech.sales@coherent.com) [www.coherent.com](http://www.coherent.com)

Coherent follows a policy of continuous product improvement. Specifications are subject to change without notice.  
 Coherent offers a limited warranty for all HRNXT SmartCleave Lasers. For full details of this warranty coverage, please refer to the Service section at [www.coherent.com](http://www.coherent.com) or contact your local Sales or Service Representative.  
 MC-028-20-0M0720 Copyright ©2020 Coherent, Inc.

