

# 1310nm, 400µm, Conduction-Cooled, Single Bar, Fiber-Coupled Module

## Features

- High coupling efficiency
- High brightness
- Sealed housing
- Standard fiber coupling (HP-SMA) for 400µm NA 0.22



## Device Specification

Optical Parameters <sup>1</sup>	Units	
Center Wavelength Range <sup>3</sup>	nm	1310
Center Wavelength Tolerance	nm	±20
Output Power <sup>2</sup>	W	14
Spectral Width (FWHM)	nm	<12
Slope Efficiency	W/A	>0.3
Wavelength Temp. Coefficient	nm/°C	~0.44

Fiber Parameters		
Numerical Aperture	NA	0.22
Fiber Core Diameter	µm	400
Fiber Connector		HP-SMA 905 with Free Standing Fiber Tips

Electrical Parameters <sup>1</sup>		
Power Conversion Efficiency	%	>18
Threshold Current ( $I_{TH}$ )	A	<10
Operating Current ( $I_{OP}$ )	A	<62
Operating Voltage ( $V_{OP}$ )	V	<1.3

Thermal Parameters		
Operating Temperature <sup>3, 4</sup>	°C	+20 to +30
Storage Temperature <sup>4</sup>	°C	0 to +55
Recommended Heatsink Capacity	W	>90

## Optional

True unpolarized output is available as an option.

<sup>1</sup>Data at 25°C cold plate temperature.

<sup>2</sup>Reduced lifetime if used above nominal operating conditions.

<sup>3</sup>Others available upon request.

<sup>4</sup>A non-condensing environment is required for storage and operation below the ambient dew point.

# 1310nm, 400µm, Conduction-Cooled, Single Bar, Fiber-Coupled Module

## Package Dimension

### Module M1F-SS2.1

(Optional monitor photo diode and temperature sensor/NTC)

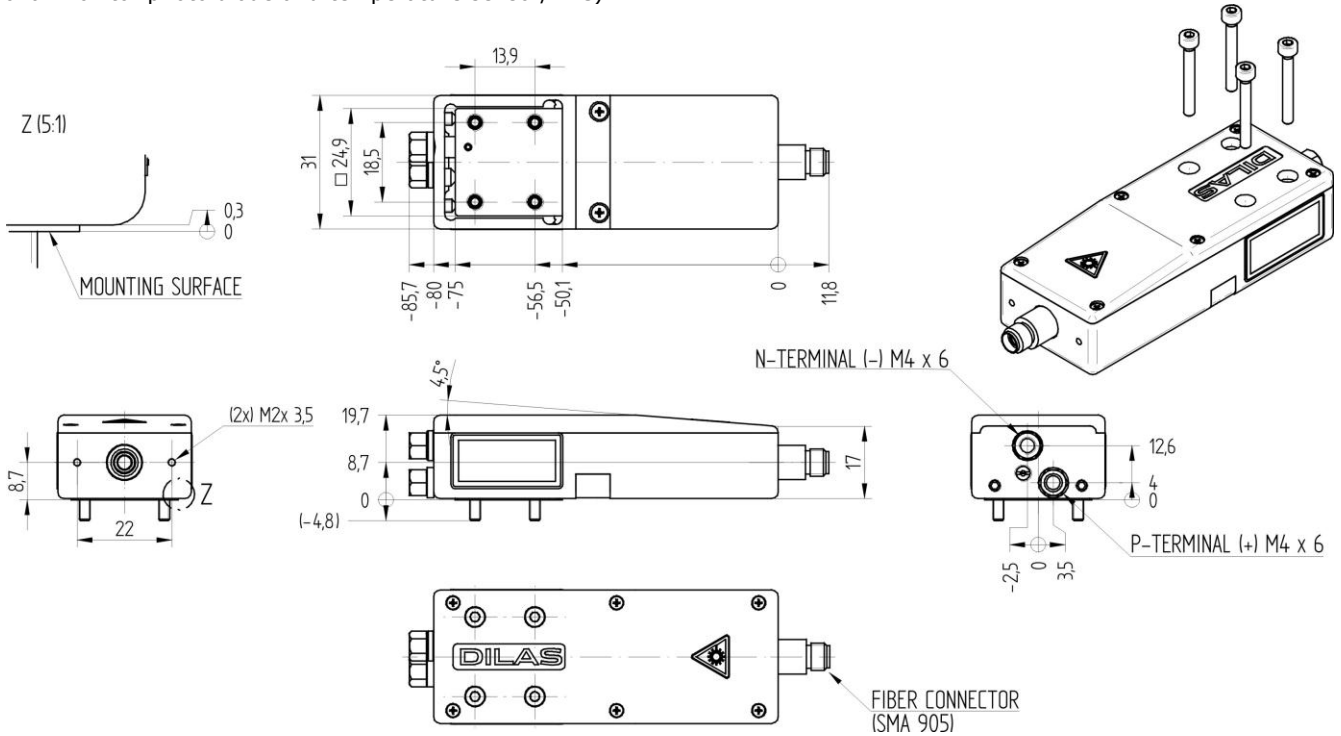

### Module M1F-SS5.2

(Includes pointer, monitor photo diode, temperature sensor/NTC and fiber interlock)

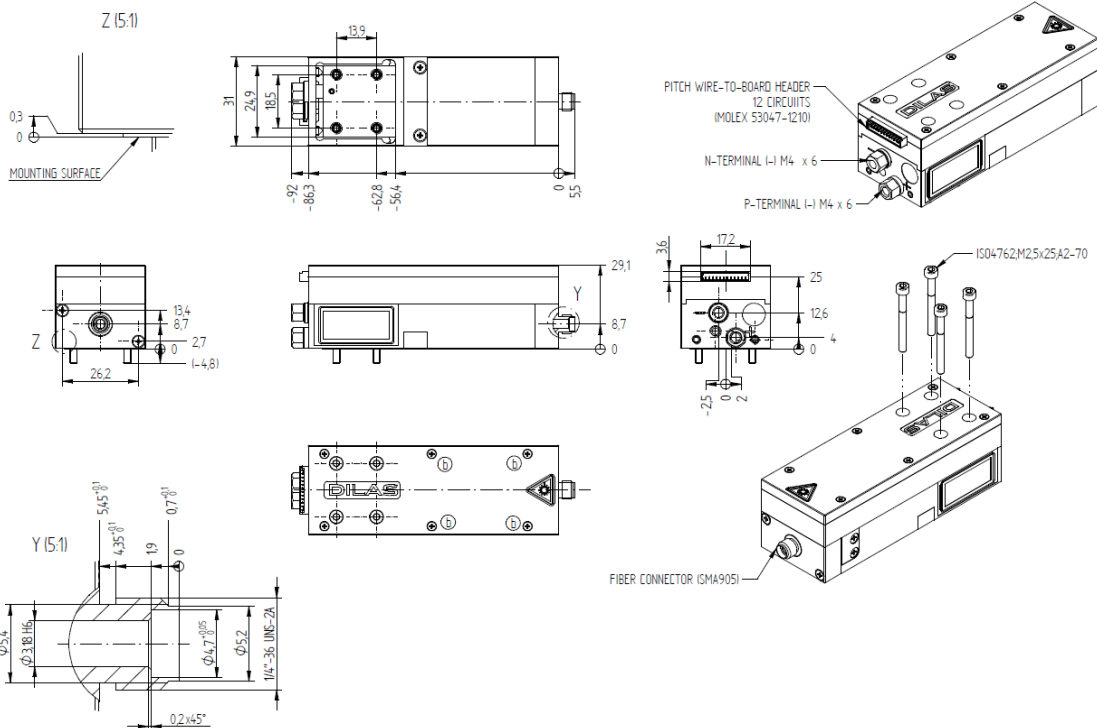

©2012 DILAS. All rights reserved. DILAS reserves the right to change product specifications without notice. For handling precautions, please reference the general handling instruction manual.

For complete details, please contact your local DILAS sales representative or visit our website at [www.DILAS.com](http://www.DILAS.com).

**Europe**  
DILAS Diodenlaser GmbH  
Galileo-Galilei-Straße 10  
55129 Mainz  
Germany  
Phone: +49 (6131) 9226 0  
Fax: +49 (6131) 9226 257  
Email: [sales@DILAS.de](mailto:sales@DILAS.de)

**North America**  
DILAS Diode Laser, Inc.  
9070 South Rita Road  
Suite 1500  
Tucson, AZ 85747  
Phone: +1 (520) 232-3484  
Fax: +1 (520) 232-3499  
Email: [sales@DILAS-INC.com](mailto:sales@DILAS-INC.com)

**Asia**  
DILAS Diodenlaser GmbH  
China Sales Office  
Room 206, Sunplus Technology, Bldg. 2  
No. 1077 Zu Chongzhi Road  
Hi-Tech Park, Shanghai 201203,  
P.R. China  
Phone: +86 (0) 21-6855-2216  
Fax: +86 (0) 21-5027-3793  
Email: [sales@dilas-china.com.cn](mailto:sales@dilas-china.com.cn)