

TAPERED AMPLIFIER FOR MOPA SETUPS

884 to 898 nm, 2000 mW, Passive Cooling

GaAs-based tapered amplifiers are used for the amplification of an existing seed laser. The seed power between 10 mW and 30 mW can be amplified up to nearly diffraction limited power values in the Watt-range. Such a setup is called MOPA (Master Oscillator Power Amplifier). The rear facet and the front facet are both provided with an antireflection coating of less than 0.01% to avoid laser action of the amplifier chip itself. Application examples for MOPA setups with tapered amplifiers are optical cooling, optical trapping, Raman spectroscopy and high-resolution absorption spectroscopy.

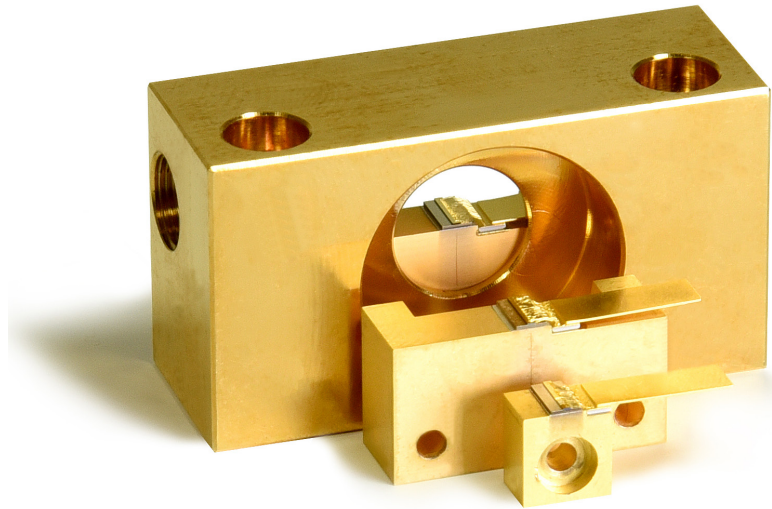

ADVANTAGES

- Tuning range between 884 nm and 898 nm
- Suitable for MOPA setups up to 2000 mW
- Nearly diffraction limited with $M^2 (1/e^2) < 1.7$
- Side mode suppression of more than 40 dB
- Highly anti-reflection facet coatings $< 0.01\%$
- Passive cooling
- Different packages available
- Customized packaging possible

OPTIONS

- The TA-0890-2000 can be mounted on a c-mount or optionally on a DHP inset or a DHP frame for better handling.
- The TA-0890-2000 can be ordered with selected beam quality parameters M^2 .
- The TA-0890-2000 is also available for external cavity configurations, see product datasheet TAL-0890-2000.

Tapered Amplifier for MOPA Setups

Optical Parameters ¹	TA-0890-2000
Wavelength Operation Range ¹ (nm)	884 to 898
Center Wavelength Range (nm)	890
ASE Suppression (dB)	≥40
Output Power (W)	2.0
Typical Seed Power ³ (mW)	15
Maximum Seed Power ³ (mW)	30
Minimum Seed Power ³ (mW)	10
Design Parameters	
Output Aperture at Front Side (μm)	256 x 1.2
Divergence Parallel (95%) (degree)	10 to 12
Divergence Perpendicular (95%) (degree)	50
M ² (1/e ²) ⁴	≤1.7
Astigmatism (μm)	Depends On Operating Conditions
Electrical Parameters	
Typical Operation Current (1000 mW) (A)	2.0
Typical Operation Current (2000 mW) (A)	3.1
Maximum Operation Current With Injection (A)	3.5
Maximum Operation Current Without Injection (A)	2.0
Maximum Operation Voltage (V)	≤1.7
Polarization	TE
Thermal Parameters	
Operating Temperature (°C)	+15 to +30
Recommended Heat Sink Temperature (°C)	20
Storage Temperature ⁵ (°C)	-20 to +60
Operating Conditions	Non-Condensing Atmosphere
Other Parameters	
Heat Sink Type ⁶	C-Mount
Cavity Length (μm)	4300
Cathode (-)	Wire Flag (see also packaging drawings)
Anode (+)	Base Plate (see also packaging drawings)
RoHS 2002/95EC Compliant	Yes

Notes:

1. Tolerance of +/-2 nm, not exceeding maximum operation current
2. Lower output power possible at periphery areas with max. operation current
3. Measured in front of rear facet, optical isolator in MOPA setup will reduce seed power of 30 to 60 mW by 50%
4. Measured in accordance to ISO 11146
5. In a non condensing atmosphere
6. Other heat sinks on request

Safety

This is a laser class IV product according to IEC -Standard International Commission (Publication 825, 1993). The laser light emitted from this laser diode is invisible and/or visible and is harmful to the human eye. The safety regulations for eye and personell protection included in the IEC Standard must be observed to avoid any harm to operating personell. Avoid direct exposure and looking into the laser diode, into the collimated beam or into the fiber when it is linked to the module.

Storage and Shipping

Store and ship the diode laser with shortened electrical contacts in a clean and dry atmosphere and in a temperture range of 0°C to 60°C.

Operation and Handling

Diode lasers are extremely sensitive to over-voltage. Take extreme precaution to avoid electrostatic charges. Precautions against spiking during switching on and off the power supply must be assured. Correct polarity of power supply must be assured.

During handling personell has to wear wrist straps. Grounded work surfaces and additional antistatic techniques are mandatory during handling. Device failure and safety hazard are caused by operation in excess of maximum ratings. Exceeding output power and temperature specification will result in accelerated device ageing.

Do not mount via any paste-like media!

Example Measurement Data

The charts presented only describe typical examples. All modules are characterised individually, the results being contained in the documentation included. The display options are subject to alteration.

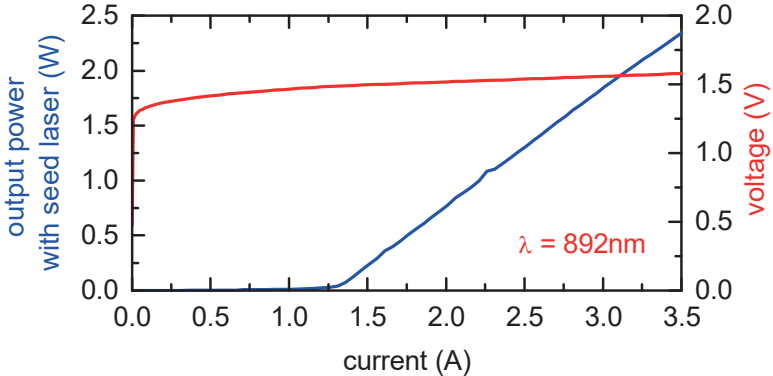

P(I) and U(I) characteristics.
All measurements have been done for 20 mW seed power and at 20 °C in cw operation.

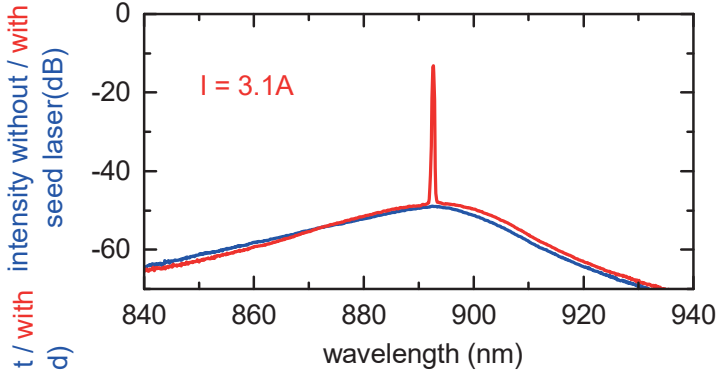

Amplifier output spectrum with and without seed power.

Operation beyond the central tuning range and power specified may induce increased thermal stress to the modules and thereby reduce its service life.

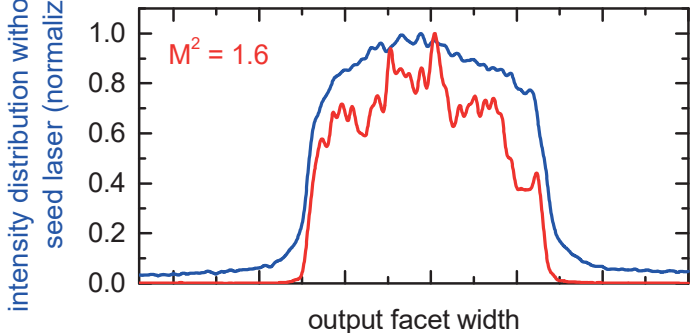

Intensity distribution at the amplifier output facet in the slow axis with seed power.

M^2 has been measured using a commercial BeamScope in accordance to ISO 11146.

Mechanical Specifications

C-Mount

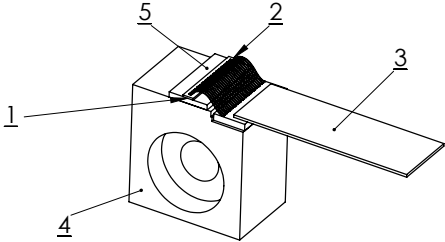
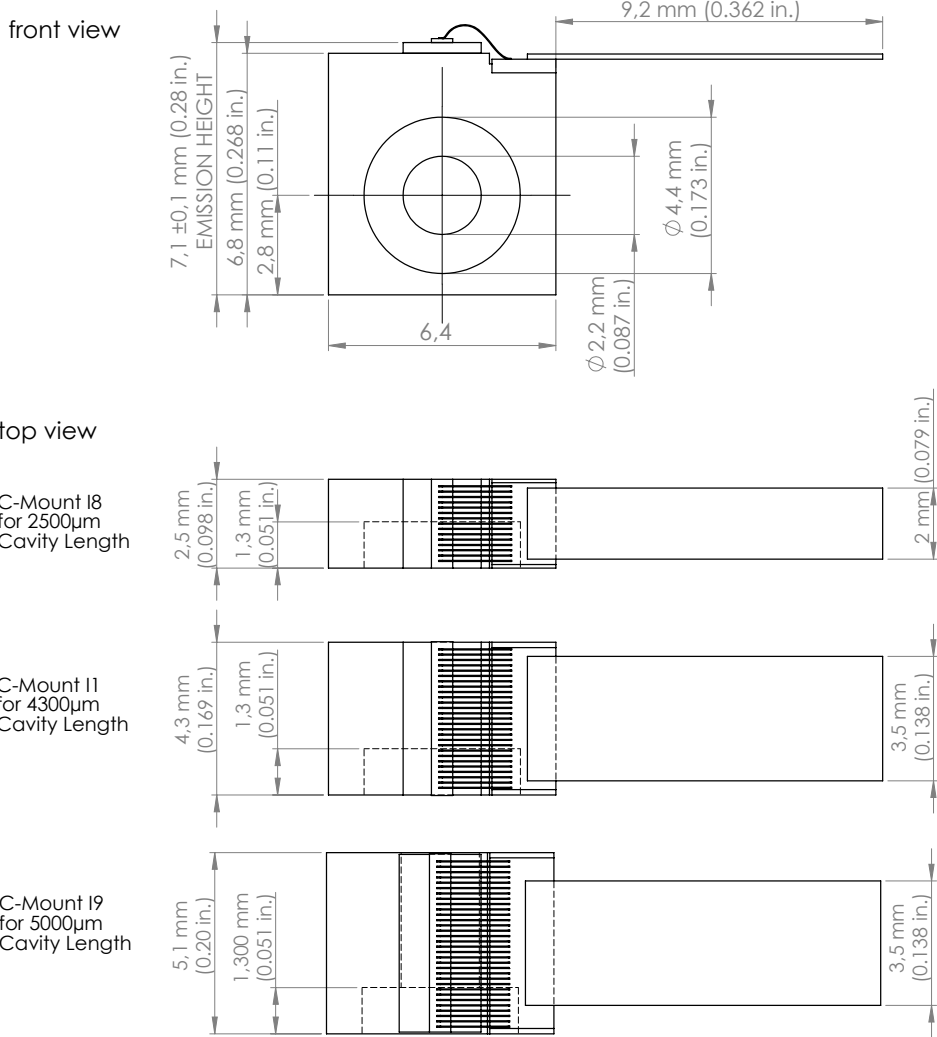

- 1 = taper facet
- 2 = ridge facet
- 3 = Cathode contact
(N-Terminal, - connection)
- 4 = Anode, body
(P-Terminal, + connection)
- 5 = CuW - Submount

Tapered Amplifier for MOPA Setups

Mechanical Specifications

DHP-Inset

front view

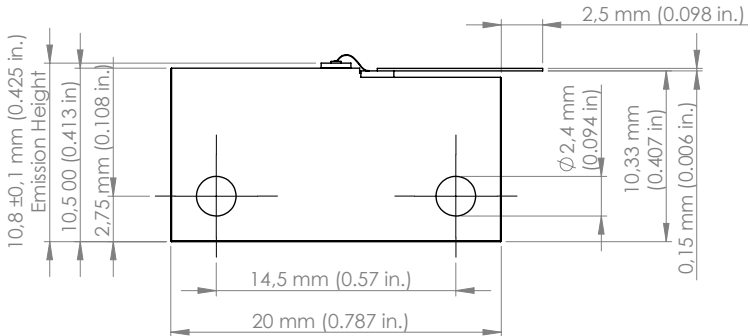

top view

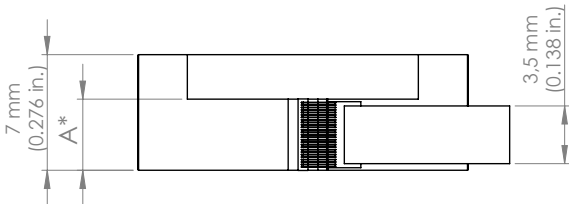

*A is equal to the cavity length (4,3 mm or 5 mm) of the tapered amplifier

rear view

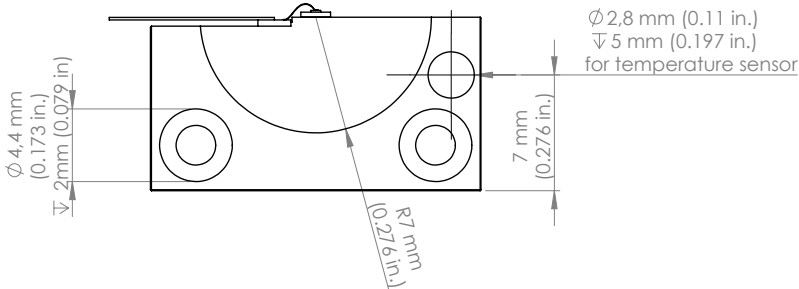

- 1 = taper facet (output)
- 2 = ridge facet
- 3 = Cathode contact (N-Terminal, - connection)
- 4 = Anode, body (P-Terminal, + connection)
- 5 = CuW-Submount

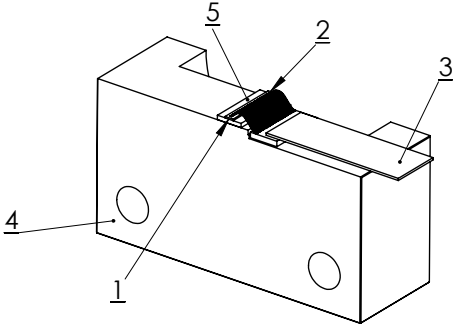

Mechanical Specifications

DHP-Frame

