

# OBIS LX/LS

## Lasers for Plug-and-Play Simplicity

The Coherent OBIS suite of products offers higher signal-to-noise ratio laser technology for a wide range of applications in the Life Sciences, Environmental Monitoring, and Inspection markets.

Our Optically Pumped Semiconductor Laser (OPSL) technology combined with our laser diode solutions delivers the industry-best laser reliability and performance. The OBIS family of smart lasers covers the wavelength spectrum—from the Ultraviolet at 375 nm to the near-Infrared at 980 nm.

The plug-and-play flexibility allows customers to integrate the product of their choice much faster, thereby reducing their time-to-market and costs.

OBIS LX/LS lasers deliver superior power, low RMS noise, and higher beam quality that are key customer needs from any laser source.

Coherent has implemented an intelligent design that allows multiple ways to interface with the laser, giving our customers the ability to choose the smartest operation process for their specific application requirements.

### FEATURES & BENEFITS

- Commonality across the spectrum in dimensions, beam and interface
- Integrated control electronics
- Analog, digital and mixed modulation modes

### APPLICATIONS

- Confocal Microscopy
- DNA Sequencing
- Flow Cytometry
- Medical Imaging and Instrumentation



SPECIFICATIONS	OBIS 375LX	OBIS 405LX	OBIS 413LX	OBIS 422LX	OBIS 445LX
Wavelength <sup>1</sup> (nm)	375	405	413	422	445
Output Power <sup>2</sup> (mW)	16, 50	50, 200, 100 250, 365	100	100	75, 365
Spatial Mode	TEM <sub>00</sub>	TEM <sub>00</sub>	TEM <sub>00</sub>	TEM <sub>00</sub>	TEM <sub>00</sub>
M <sup>2</sup> (Beam Quality) <sup>3</sup>	≤1.3	≤1.2 ≤1.3	≤1.2	≤1.2	≤1.2
Beam Asymmetry	≤1:1.2	≤1:1.2	≤1:1.2	≤1:1.2	≤1:1.2
Beam Diameter at 1/e <sup>2</sup> (mm)	0.7 ±0.1	0.8 ±0.1	0.8 ±0.1	0.9 ±0.1	0.6 ±0.1
Beam Divergence (mrad, full-angle)	<1	<1	<1	<1.1	<1.1
Pointing Stability (μrad) (over 2 hours after warm-up and ±3°C)	<30	<30	<30	<30	<30
Pointing Stability Over Temp. (μrad/°C)	<5	<5	<5	<5	<5
RMS Noise (%) (20 Hz to 20 MHz)	≤0.05	≤0.05	≤0.05	≤0.05	≤0.05
Peak-to-Peak Noise (%) (20 Hz to 20 kHz)	<0.5	<0.5	<0.5	<0.5	<0.5
Long-term Power Stability (%) (8 hrs., ±3°C)	<2	<2	<2	<2	<2
Warm-up Time <sup>4</sup> (minutes) (from cold start)	<5	<5	<5	<5	<5
Polarization Ratio	Minimum 100:1, Vertical ±5°				
Laser Drive Modes	CW, Analog Modulation, Digital Modulation and Computer Control				
Digital Modulation					
Maximum Bandwidth (MHz)	75	150	150	150	150
Rise Time (10% to 90%) (nsec)	<5	<2	<2	<2	<2
Fall Time (90% to 10%) (nsec)	<5	<2	<2	<2	<2
Modulation Depth (extinction ratio)	>1,000,000:1 at 0 Hz, >250:1 at 75 MHz	>1,000,000:1 at 0 Hz, >250:1 at 150 MHz	>1,000,000:1 at 0 Hz, >250:1 at 150 MHz	>1,000,000:1 at 0 Hz, >250:1 at 150 MHz	>1,000,000:1 at 0 Hz, >250:1 at 150 MHz
Analog Modulation					
Maximum Bandwidth (kHz)	500	500	500	500	500
Rise Time (10% to 90%) (nsec)	<700	<700	<700	<700	<700
Fall Time (90% to 10%) (nsec)	<700	<700	<700	<700	<700
Modulation Depth (extinction ratio)	>1,000,000:1	>1,000,000:1	>1,000,000:1	>1,000,000:1	>1,000,000:1
Static Alignment Tolerances					
Beam Position from Reference <sup>5</sup> (mm)	<1	<1	<1	<1	<1
Beam Angle <sup>5</sup> (mrad)	<5	<5	<5	<5	<5
Beam Waist Position at Exit Window (mm)	n/a	n/a	n/a	n/a	n/a
Laser Safety Classification	3b	3b	3b	3b	3b
ESD Protection	EN61326-1	EN61326-1	EN61326-1	EN61326-1	EN61326-1
Power Consumption (W)	Typical 5, Max. 13	Typical 5, Max. 13	Typical 5, Max. 13	Typical 5, Max. 13	Typical 5, Max. 13
Laser Head Baseplate Temp. (Max., °C)	50	50	50	50	50
Heat Dissipation of Laser Head <sup>6</sup> (W)	Typical 5, Max. 13	Typical 5, Max. 13	Typical 5, Max. 13	Typical 5, Max. 13	Typical 5, Max. 13
Ambient Temperature <sup>7</sup>					
Operating Condition <sup>8</sup> (°C)	10 to 50	10 to 50	10 to 50	10 to 50	10 to 50
Non-operating Condition (°C)	-20 to 60	-20 to 60	-20 to 60	-20 to 60	-20 to 60
Shock Tolerance (g) (6 ms)	30	30	30	30	30

1 Laser-to-laser wavelength tolerance ±2 nm for all OBIS LS versions. For OBIS LX wavelength tolerance of ±5 nm except for 413LX with a 410 nm to 420 nm range; 445LX at 365 mW with a 435 nm to 450 nm range; 458LX at 365 mW with a 450 nm to 465 nm range; 522LX with a 520 nm to 530 nm range; 633LX with a 629 nm to 636 nm range; 640LX with 635 nm to 644 nm range; 660LX with 652 nm to 665 nm range; and 685LX, 730LX, 750LX, 785LX, 808LX, and 980LX with a ±10 nm range.

2 Output power is variable in CW Mode from 1 mW (1% for LX Models) to 110% of rated power. Specifications are valid for 100% power. For LS versions all residual laser emission at 808 nm pump/trigger or fundamental <0.1 mW.

3 For LX versions the M<sup>2</sup> measured with ModeMaster with 90/10 clip levels.

4 For LS versions typical power-on delay 1 minute. For LX versions typical power-on delay of 0.1 minutes.

5 See mechanical drawing for exit beam location.

6 Typically 85% of heat load through the base plate. See Users Manual for more detail.

7 Non-Condensing. See User Manual for more detail.

8 For LS versions laser head baseplate temperature needs to be maintained at ≤40°C.

SPECIFICATIONS	OBIS 458LX	OBIS 473LX	OBIS 488LX	OBIS 488LS
Wavelength <sup>1</sup> (nm)	458	473	488	488
Output Power <sup>2</sup> (mW)	75      365	75	50      150	20, 60, 80, 100, 150
Spatial Mode	TEM <sub>00</sub>	TEM <sub>00</sub>	TEM <sub>00</sub>	TEM <sub>00</sub>
M <sup>2</sup> (Beam Quality) <sup>3</sup>	≤1.2	≤1.2	≤1.2	≤1.1
Beam Asymmetry	≤1:1.2	≤1:1.2	≤1:1.2	≤1:1.1
Beam Diameter at 1/e <sup>2</sup> (mm)	0.7 ±0.1	0.8 ±0.1	0.8 ±0.1    0.7 ±0.1	0.7 ±0.05
Beam Divergence (mrad, full-angle)	<1.1	<1.1	<1.2	<1.2
Pointing Stability (μrad) (over 2 hours after warm-up and ±3°C)	<30	<30	<30	<30
Pointing Stability Over Temp. (μrad/°C)	<5	<5	<5	<5
RMS Noise (%) (20 Hz to 20 MHz)	≤0.05	≤0.05	≤0.05	≤0.25
Peak-to-Peak Noise (%) (20 Hz to 20 kHz)	<0.5	<0.5	<0.5	<1
Long-term Power Stability (%) (8 hrs., ±3°C)	<2	<2	<2	<2
Warm-up Time <sup>4</sup> (minutes) (from cold start)	<5	<5	<5	<5
Polarization Ratio	Minimum 100:1, Vertical ±5°			
Laser Drive Modes	CW, Analog Modulation, Digital Modulation and Computer Control			
Digital Modulation				
Maximum Bandwidth (MHz)	150	150	150	0.05
Rise Time (10% to 90%) (nsec)	<2	<2	<2	<18,000
Fall Time (90% to 10%) (nsec)	<2	<2	<2.5	<2000
Modulation Depth (extinction ratio)	>1,000,000:1 at 0 Hz, >250:1 at 75 MHz	>1,000,000:1 at 0 Hz, >250:1 at 150 MHz	>1,000,000:1 at 0 Hz, >250:1 at 150 MHz	Infinite at 0 Hz to 50 kHz
Analog Modulation				
Maximum Bandwidth (kHz)	500	500	500	100
Rise Time (10% to 90%) (nsec)	<700	<700	<700	<3000
Fall Time (90% to 10%) (nsec)	<700	<700	<700	<3000
Modulation Depth (extinction ratio)	>1,000,000:1	>1,000,000:1	>1,000,000:1	>50:1
Static Alignment Tolerances				
Beam Position from Reference <sup>5</sup> (mm)	<1	<1	<1	<0.5
Beam Angle <sup>5</sup> (mrad)	<5	<5	<5	<2.5
Beam Waist Position at Exit Window (mm)	n/a	n/a	n/a	±200
Laser Safety Classification	3b	3b	3b	3b
ESD Protection	EN61326-1	EN61326-1	EN61326-1	EN61326-1
Power Consumption (W)	Typical 5, Max. 13	Typical 5, Max. 13	Typical 5, Max. 13	Typical 8, Max. 12
Laser Head Baseplate Temp. (Max., °C)	50	50	50	40
Heat Dissipation of Laser Head <sup>6</sup> (W)	Typical 5, Max. 13	Typical 5, Max. 13	Typical 5, Max. 13	Typical 8, Max. 12
Ambient Temperature <sup>7</sup>				
Operating Condition <sup>8</sup> (°C)	10 to 50	10 to 50	10 to 50	15 to 40
Non-operating Condition (°C)	-20 to 60	-20 to 60	-20 to 60	-20 to 60
Shock Tolerance (g) (6 ms)	30	30	30	30

<sup>1</sup> Laser-to-laser wavelength tolerance ±2 nm for all OBIS LS versions. For OBIS LX wavelength tolerance of ±5 nm except for 413LX with a 410 nm to 420 nm range; 445LX at 365 mW with a 435 nm to 450 nm range; 458LX at 365 mW with a 450 nm to 465 nm range; 522LX with a 520 nm to 530 nm range; 633LX with a 629 nm to 636 nm range; 640LX with 635 nm to 644 nm range; 660LX with 652 nm to 665 nm range; and 685LX, 730LX, 750LX, 785LX, 808LX, and 980LX with a ±10 nm range.

<sup>2</sup> Output power is variable in CW Mode from 1 mW (1% for LX Models) to 110% of rated power. Specifications are valid for 100% power. For LS versions all residual laser emission at 808 nm pump light or fundamental <0.1 mW.

<sup>3</sup> For LX versions the M<sup>2</sup> measured with ModeMaster with 90/10 clip levels.

<sup>4</sup> For LS versions typical power-on delay 1 minute. For LX versions typical power-on delay of 0.1 minutes.

<sup>5</sup> See mechanical drawing for exit beam location.

<sup>6</sup> Typically 85% of heat load through the base plate. See Users Manual for more detail.

<sup>7</sup> Non-Condensing. See User Manual for more detail.

<sup>8</sup> For LS versions laser head baseplate temperature needs to be maintained at ≤40°C.

SPECIFICATIONS	OBIS 505LX	OBIS 505LS	OBIS 514LX	OBIS 514LS	OBIS 522LX
Wavelength <sup>1</sup> (nm)	505	505	514	514	522
Output Power <sup>2</sup> (mW)	50	30, 100	40	20, 100, 150	40
Spatial Mode	TEM <sub>00</sub>	TEM <sub>00</sub>	TEM <sub>00</sub>	TEM <sub>00</sub>	TEM <sub>00</sub>
M <sup>2</sup> (Beam Quality) <sup>3</sup>	≤1.2	≤1.1	≤1.2	≤1.1	≤1.2
Beam Asymmetry	≤1:1.2	≤1:1.1	≤1:1.2	≤1:1.1	≤1:1.2
Beam Diameter at 1/e <sup>2</sup> (mm)	0.7 ±0.1	0.7 ±0.05	0.6 ±0.1	0.7 ±0.05	0.6 ±0.1
Beam Divergence (mrad, full-angle)	<1.2	<1.2	<1.1	<1.2	<1.1
Pointing Stability (μrad) (over 2 hours after warm-up and ±3°C)	<30	<30	<30	<30	<30
Pointing Stability Over Temp. (μrad/°C)	<5	<5	<5	<5	<5
RMS Noise (%) (20 Hz to 20 MHz)	≤0.05	≤0.25	≤0.05	≤0.25	≤0.05
Peak-to-Peak Noise (%) (20 Hz to 20 kHz)	<0.5	<1	<1	<1	<1
Long-term Power Stability (%) (8 hrs., ±3°C)	<2	<2	<2	<2	<2
Warm-up Time <sup>4</sup> (minutes) (from cold start)	<5	<5	<5	<5	<5
Polarization Ratio	Minimum 100:1, Vertical ±5°				
Laser Drive Modes	CW, Analog Modulation, Digital Modulation and Computer Control				
Digital Modulation					
Maximum Bandwidth (MHz)	150	0.05	100	0.05	100
Rise Time (10% to 90%) (nsec)	<2	<18,000	<3.5	<18,000	<3.5
Fall Time (90% to 10%) (nsec)	<2.5	<2000	<2	<2000	<2
Modulation Depth (extinction ratio)	>1,000,000:1 at 0 Hz, >250:1 at 150 MHz	Infinite at 0 Hz to 50 kHz	>1,000,000:1 at 0 Hz, >250:1 at 100 MHz	Infinite at 0 Hz to 50 kHz	>1,000,000:1 at 0 Hz, >250:1 at 100 MHz
Analog Modulation					
Maximum Bandwidth (kHz)	500	100	500	100	500
Rise Time (10% to 90%) (nsec)	<700	<3000	<700	<3000	<700
Fall Time (90% to 10%) (nsec)	<700	<3000	<700	<3000	<700
Modulation Depth (extinction ratio)	>1,000,000:1	>50:1	>1,000,000:1	>50:1	>1,000,000:1
Static Alignment Tolerances					
Beam Position from Reference <sup>5</sup> (mm)	<1	<0.5	<1	<0.5	<1
Beam Angle <sup>5</sup> (mrad)	<5	<2.5	<5	<2.5	<5
Beam Waist Position at Exit Window (mm)	n/a	±200	n/a	±200	n/a
Laser Safety Classification	3b	3b	3b	3b	3b
ESD Protection	EN61326-1	EN61326-1	EN61326-1	EN61326-1	EN61326-1
Power Consumption (W)	Typical 5, Max. 13	Typical 8, Max. 12	Typical 5, Max. 13	Typical 8, Max. 12	Typical 5, Max. 13
Laser Head Baseplate Temp. (Max., °C)	50	40	50	40	50
Heat Dissipation of Laser Head <sup>6</sup> (W)	Typical 5, Max. 13	Typical 8, Max. 12	Typical 5, Max. 13	Typical 8, Max. 12	Typical 5, Max. 13
Ambient Temperature <sup>7</sup>					
Operating Condition <sup>8</sup> (°C)	10 to 50	15 to 40	10 to 50	15 to 40	10 to 50
Non-operating Condition (°C)	-20 to 60	-20 to 60	-20 to 60	-20 to 60	-20 to 60
Shock Tolerance (g) (6 ms)	30	30	30	30	30

<sup>1</sup> Laser-to-laser wavelength tolerance ±2 nm for all OBIS LS versions. For OBIS LX wavelength tolerance of ±5 nm except for 413LX with a 410 nm to 420 nm range; 445LX at 365 mW with a 435 nm to 450 nm range; 458LX at 365 mW with a 450 nm to 465 nm range; 522LX with a 520 nm to 530 nm range; 633LX with a 629 nm to 636 nm range; 640LX with 635 nm to 644 nm range; 660LX with 652 nm to 665 nm range; and 685LX, 730LX, 750LX, 785LX, 808LX, and 980LX with a ±10 nm range.

<sup>2</sup> Output power is variable in CW Mode from 1 mW (1% for LX Models) to 110% of rated power. Specifications are valid for 100% power. For LS versions all residual laser emission at 808 nm pump light or fundamental <0.1 mW.

<sup>3</sup> For LX versions the M<sup>2</sup> measured with ModeMaster with 90/10 clip levels.

<sup>4</sup> For LS versions typical power-on delay 1 minute. For LX versions typical power-on delay of 0.1 minutes.

<sup>5</sup> See mechanical drawing for exit beam location.

<sup>6</sup> Typically 85% of heat load through the base plate. See Users Manual for more detail.

<sup>7</sup> Non-Condensing. See User Manual for more detail.

<sup>8</sup> For LS versions laser head baseplate temperature needs to be maintained at ≤40°C.

SPECIFICATIONS	OBIS 532LS	OBIS 552LS	OBIS 561LS	OBIS 594LS
Wavelength <sup>1</sup> (nm)	532	552	561	594
Output Power <sup>2</sup> (mW)	20, 50, 80, 100, 150	20, 60, 80, 100, 150	20, 50, 80, 100, 150	20, 60, 100
Spatial Mode	TEM <sub>00</sub>	TEM <sub>00</sub>	TEM <sub>00</sub>	TEM <sub>00</sub>
M <sup>2</sup> (Beam Quality) <sup>3</sup>	≤1.1	≤1.1	≤1.1	≤1.1
Beam Asymmetry	≤1:1.1	≤1:1.1	≤1:1.1	≤1:1.1
Beam Diameter at 1/e <sup>2</sup> (mm)	0.7 ±0.05	0.7 ±0.05	0.7 ±0.05	0.7 ±0.05
Beam Divergence (mrad, full-angle)	<1.2	<1.2	<1.2	<1.3
Pointing Stability (μrad) (over 2 hours after warm-up and ±3°C)	<30	<30	<30	<30
Pointing Stability Over Temp. (μrad/°C)	<5	<5	<5	<5
RMS Noise (%) (20 Hz to 20 MHz)	≤0.25	≤0.25	≤0.25	≤0.25
Peak-to-Peak Noise (%) (20 Hz to 20 kHz)	<1	<1	<1	<1
Long-term Power Stability (%) (8 hrs., ±3°C)	<2	<2	<2	<2
Warm-up Time <sup>4</sup> (minutes) (from cold start)	<5	<5	<5	<5
Polarization Ratio	Minimum 100:1, Vertical ±5°			
Laser Drive Modes	CW, Analog Modulation, Digital Modulation and Computer Control			
Digital Modulation				
Maximum Bandwidth (MHz)	0.05	0.05	0.05	0.05
Rise Time (10% to 90%) (nsec)	<18,000	<18,000	<18,000	<18,000
Fall Time (90% to 10%) (nsec)	<2000	<2000	<2000	<2000
Modulation Depth (extinction ratio)	Infinite at 0 Hz to 50 kHz	Infinite at 0 Hz to 50 kHz	Infinite at 0 Hz to 50 kHz	Infinite at 0 Hz to 50 kHz
Analog Modulation				
Maximum Bandwidth (kHz)	100	100	100	100
Rise Time (10% to 90%) (nsec)	<3000	<3000	<3000	<3000
Fall Time (90% to 10%) (nsec)	<3000	<3000	<3000	<3000
Modulation Depth (extinction ratio)	>50:1	>50:1	>50:1	>50:1
Static Alignment Tolerances				
Beam Position from Reference <sup>5</sup> (mm)	<0.5	<0.5	<0.5	<0.5
Beam Angle <sup>5</sup> (mrad)	<2.5	<2.5	<2.5	<2.5
Beam Waist Position at Exit Window (mm)	±200	±200	±200	±200
Laser Safety Classification	3b	3b	3b	3b
ESD Protection	EN61326-1	EN61326-1	EN61326-1	EN61326-1
Power Consumption (W)	Typical 8, Max. 12	Typical 8, Max. 12	Typical 8, Max. 12	Typical 8, Max. 12
Laser Head Baseplate Temp. (Max., °C)	40	40	40	40
Heat Dissipation of Laser Head <sup>6</sup> (W)	Typical 8, Max. 12	Typical 8, Max. 12	Typical 8, Max. 12	Typical 8, Max. 12
Ambient Temperature <sup>7</sup>				
Operating Condition <sup>8</sup> (°C)	15 to 40	15 to 40	15 to 40	15 to 40
Non-operating Condition (°C)	-20 to 60	-20 to 60	-20 to 60	-20 to 60
Shock Tolerance (g) (6 ms)	30	30	30	30

<sup>1</sup> Laser-to-laser wavelength tolerance ±2 nm for all OBIS LS versions. For OBIS LX wavelength tolerance of ±5 nm except for 413LX with a 410 nm to 420 nm range; 445LX at 365 mW with a 435 nm to 450 nm range; 458LX at 365 mW with a 450 nm to 465 nm range; 522LX with a 520 nm to 530 nm range; 633LX with a 629 nm to 636 nm range; 640LX with 635 nm to 644 nm range; 660LX with 652 nm to 665 nm range; and 685LX, 730LX, 750LX, 785LX, 808LX, and 980LX with a ±10 nm range.

<sup>2</sup> Output power is variable in CW Mode from 1 mW (1% for LX Models) to 110% of rated power. Specifications are valid for 100% power. For LS versions all residual laser emission at 808 nm pump/trigger or fundamental <0.1 mW.

<sup>3</sup> For LX versions the M<sup>2</sup> measured with ModeMaster with 90/10 clip levels.

<sup>4</sup> For LS versions typical power-on delay 1 minute. For LX versions typical power-on delay of 0.1 minutes.

<sup>5</sup> See mechanical drawing for exit beam location.

<sup>6</sup> Typically 85% of heat load through the base plate. See Users Manual for more detail.

<sup>7</sup> Non-Condensing. See User Manual for more detail.

<sup>8</sup> For LS versions laser head baseplate temperature needs to be maintained at ≤40°C.

SPECIFICATIONS	OBIS 633LX	OBIS 637LX	OBIS 640LX	OBIS 647LX
Wavelength <sup>1</sup> (nm)	633	637	640	647
Output Power <sup>2</sup> (mW)	70	140, 160	40, 100	120
Spatial Mode	TEM <sub>00</sub>	TEM <sub>00</sub>	TEM <sub>00</sub>	TEM <sub>00</sub>
M <sup>2</sup> (Beam Quality) <sup>3</sup>	≤1.2	≤1.2	≤1.2	≤1.2
Beam Asymmetry	≤1:1.2	≤1:1.2	≤1:1.2	≤1:1.2
Beam Diameter at 1/e <sup>2</sup> (mm)	0.7 ±0.1	0.7 ±0.1	0.8 ±0.1	0.8 ±0.1
Beam Divergence (mrad, full-angle)	<1.3	<1.3	<1.3	<1.3
Pointing Stability (μrad) (over 2 hours after warm-up and ±3°C)	<30	<30	<30	<30
Pointing Stability Over Temp. (μrad/°C)	<5	<5	<5	<5
RMS Noise (%) (20 Hz to 20 MHz)	≤0.05	≤0.05	≤0.05	≤0.05
Peak-to-Peak Noise (%) (20 Hz to 20 kHz)	<0.5	<0.5	<0.5	<0.5
Long-term Power Stability (%) (8 hrs., ±3°C)	<2	<2	<2	<2
Warm-up Time <sup>4</sup> (minutes) (from cold start)	<5	<5	<5	<5
Polarization Ratio	Minimum 100:1, Vertical ±5°			
Laser Drive Modes	CW, Analog Modulation, Digital Modulation and Computer Control			
Digital Modulation				
Maximum Bandwidth (MHz)	150	150	150	150
Rise Time (10% to 90%) (nsec)	<2	<2	<2	<2
Fall Time (90% to 10%) (nsec)	<2	<2	<2	<2
Modulation Depth (extinction ratio)	>1,000,000:1 at 0 Hz, >250:1 at 150 MHz	>1,000,000:1 at 0 Hz, >250:1 at 150 MHz	>1,000,000:1 at 0 Hz, >250:1 at 150 MHz	>1,000,000:1 at 0 Hz, >250:1 at 150 MHz
Analog Modulation				
Maximum Bandwidth (kHz)	500	300	500	500
Rise Time (10% to 90%) (nsec)	<700	<1200	<700	<700
Fall Time (90% to 10%) (nsec)	<700	<800	<700	<700
Modulation Depth (extinction ratio)	>1,000,000:1	>1,000,000:1	>1,000,000:1	>1,000,000:1
Static Alignment Tolerances				
Beam Position from Reference <sup>5</sup> (mm)	<1	<1	<1	<1
Beam Angle <sup>5</sup> (mrad)	<5	<5	<5	<5
Beam Waist Position at Exit Window (mm)	n/a	n/a	n/a	n/a
Laser Safety Classification	3b	3b	3b	3b
ESD Protection	EN61326-1	EN61326-1	EN61326-1	EN61326-1
Power Consumption (W)	Typical 5, Max. 13	Typical 5, Max. 13	Typical 5, Max. 13	Typical 5, Max. 13
Laser Head Baseplate Temp. (Max., °C)	50	50	50	50
Heat Dissipation of Laser Head <sup>6</sup> (W)	Typical 5, Max. 13	Typical 5, Max. 13	Typical 5, Max. 13	Typical 5, Max. 13
Ambient Temperature <sup>7</sup>				
Operating Condition <sup>8</sup> (°C)	10 to 50	10 to 50	10 to 50	10 to 50
Non-operating Condition (°C)	-20 to 60	-20 to 60	-20 to 60	-20 to 60
Shock Tolerance (g) (6 ms)	30	30	30	30

<sup>1</sup> Laser-to-laser wavelength tolerance ±2 nm for all OBIS LS versions. For OBIS LX wavelength tolerance of ±5 nm except for 413LX with a 410 nm to 420 nm range; 445LX at 365 mW with a 435 nm to 450 nm range; 458LX at 365 mW with a 450 nm to 465 nm range; 522LX with a 520 nm to 530 nm range; 633LX with a 629 nm to 636 nm range; 640LX with 635 nm to 644 nm range; 660LX with 652 nm to 665 nm range; and 685LX, 730LX, 750LX, 785LX, 808LX, and 980LX with a ±10 nm range.

<sup>2</sup> Output power is variable in CW Mode from 1 mW (1% for LX Models) to 110% of rated power. Specifications are valid for 100% power. For LS versions all residual laser emission at 808 nm pump light or fundamental <0.1 mW.

<sup>3</sup> For LX versions the M<sup>2</sup> measured with ModeMaster with 90/10 clip levels.

<sup>4</sup> For LS versions typical power-on delay 1 minute. For LX versions typical power-on delay of 0.1 minutes.

<sup>5</sup> See mechanical drawing for exit beam location.

<sup>6</sup> Typically 85% of heat load through the base plate. See Users Manual for more detail.

<sup>7</sup> Non-Condensing. See User Manual for more detail.

<sup>8</sup> For LS versions laser head baseplate temperature needs to be maintained at ≤40°C.

SPECIFICATIONS	OBIS 660LX	OBIS 685LX	OBIS 730LX
Wavelength <sup>1</sup> (nm)	660	685	730
Output Power <sup>2</sup> (mW)	100	40	30
Spatial Mode	TEM <sub>00</sub>	TEM <sub>00</sub>	TEM <sub>00</sub>
M <sup>2</sup> (Beam Quality) <sup>3</sup>	≤1.2	≤1.2	≤1.2
Beam Asymmetry	≤1:1.2	≤1:1.2	≤1:1.2
Beam Diameter at 1/e <sup>2</sup> (mm)	0.9 ±0.1	0.8 ±0.1	0.8 ±0.1
Beam Divergence (mrad, full-angle)	<1.3	<1.3	<1.3
Pointing Stability (μrad) (over 2 hours after warm-up and ±3°C)	<30	<30	<30
Pointing Stability Over Temp. (μrad/°C)	<5	<5	<5
RMS Noise (%) (20 Hz to 20 MHz)	≤0.05	≤0.05	≤0.05
Peak-to-Peak Noise (%) (20 Hz to 20 kHz)	<0.5	<0.5	<0.5
Long-term Power Stability (%) (8 hrs., ±3°C)	<2	<2	<2
Warm-up Time <sup>4</sup> (minutes) (from cold start)	<5	<5	<5
Polarization Ratio	Minimum 100:1, Vertical ±5°		
Laser Drive Modes	CW, Analog Modulation, Digital Modulation and Computer Control		
Digital Modulation			
Maximum Bandwidth (MHz)	150	150	150
Rise Time (10% to 90%) (nsec)	<2	<2	<2
Fall Time (90% to 10%) (nsec)	<2	<2	<2
Modulation Depth (extinction ratio)	>1,000,000:1 at 0 Hz, >250:1 at 150 MHz	>1,000,000:1 at 0 Hz, >250:1 at 150 MHz	>1,000,000:1 at 0 Hz, >250:1 at 150 MHz
Analog Modulation			
Maximum Bandwidth (kHz)	500	500	500
Rise Time (10% to 90%) (nsec)	<700	<700	<700
Fall Time (90% to 10%) (nsec)	<700	<700	<700
Modulation Depth (extinction ratio)	>1,000,000:1	>1,000,000:1	>1,000,000:1
Static Alignment Tolerances			
Beam Position from Reference <sup>5</sup> (mm)	<1	<1	<1
Beam Angle <sup>5</sup> (mrad)	<5	<5	<5
Beam Waist Position at Exit Window (mm)	n/a	n/a	n/a
Laser Safety Classification	3b	3b	3b
ESD Protection	EN61326-1	EN61326-1	EN61326-1
Power Consumption (W)	Typical 5, Max. 13	Typical 5, Max. 13	Typical 5, Max. 13
Laser Head Baseplate Temp. (Max., °C)	50	50	50
Heat Dissipation of Laser Head <sup>6</sup> (W)	Typical 5, Max. 13	Typical 5, Max. 13	Typical 5, Max. 13
Ambient Temperature <sup>7</sup>			
Operating Condition <sup>8</sup> (°C)	10 to 50	10 to 50	10 to 50
Non-operating Condition (°C)	-20 to 60	-20 to 60	-20 to 60
Shock Tolerance (g) (6 ms)	30	30	30

<sup>1</sup> Laser-to-laser wavelength tolerance ±2 nm for all OBIS LS versions. For OBIS LX wavelength tolerance of ±5 nm except for 413LX with a 410 nm to 420 nm range; 445LX at 365 mW with a 435 nm to 450 nm range; 458LX at 365 mW with a 450 nm to 465 nm range; 522LX with a 520 nm to 530 nm range; 633LX with a 629 nm to 636 nm range; 640LX with 635 nm to 644 nm range; 660LX with 652 nm to 665 nm range; and 685LX, 730LX, 750LX, 785LX, 808LX, and 980LX with a ±10 nm range.

<sup>2</sup> Output power is variable in CW Mode from 1 mW (1% for LX Models) to 110% of rated power. Specifications are valid for 100% power. For LS versions all residual laser emission at 808 nm pumplight or fundamental <0.1 mW.

<sup>3</sup> For LX versions the M<sup>2</sup> measured with ModeMaster with 90/10 clip levels.

<sup>4</sup> For LS versions typical power-on delay 1 minute. For LX versions typical power-on delay of 0.1 minutes.

<sup>5</sup> See mechanical drawing for exit beam location.

<sup>6</sup> Typically 85% of heat load through the base plate. See Users Manual for more detail.

<sup>7</sup> Non-Condensing. See User Manual for more detail.

<sup>8</sup> For LS versions laser head baseplate temperature needs to be maintained at ≤40°C.



SPECIFICATIONS	OBIS 750LX	OBIS 785LX	OBIS 808LX	OBIS 980LX
Wavelength <sup>1</sup> (nm)	750	785	808	980
Output Power <sup>2</sup> (mW)	20	100	150	100, 150
Spatial Mode	TEM <sub>00</sub>	TEM <sub>00</sub>	TEM <sub>00</sub>	TEM <sub>00</sub>
M <sup>2</sup> (Beam Quality) <sup>3</sup>	≤1.2	≤1.2	≤1.2	≤1.3
Beam Asymmetry	≤1:1.2	≤1:1.2	≤1:1.2	≤1:1.3
Beam Diameter at 1/e <sup>2</sup> (mm)	0.7 ±0.1	0.7 ±0.1	0.7 ±0.1	0.7 ±0.1
Beam Divergence (mrad, full-angle)	<1.7	<1.7	<2.1	<2.8
Pointing Stability (μrad) (over 2 hours after warm-up and ±3°C)	<30	<30	<30	<30
Pointing Stability Over Temp. (μrad/°C)	<5	<5	<5	<5
RMS Noise (%) (20 Hz to 20 MHz)	≤0.05	≤0.05	≤0.05	≤0.05
Peak-to-Peak Noise (%) (20 Hz to 20 kHz)	<0.5	<0.5	<0.5	<0.5
Long-term Power Stability (%) (8 hrs., ±3°C)	<2	<2	<2	<2
Warm-up Time <sup>4</sup> (minutes) (from cold start)	<5	<5	<5	<5
Polarization Ratio	Minimum 50:1, Horizontal ±10°	Minimum 100:1, Vertical ±5°	Minimum 50:1, Vertical ±5°	Minimum 100:1, Vertical ±5°
Laser Drive Modes	CW, Analog Modulation, Digital Modulation and Computer Control			
Digital Modulation				
Maximum Bandwidth (MHz)	150	150	150	150
Rise Time (10% to 90%) (nsec)	<2	<2	<2	<2
Fall Time (90% to 10%) (nsec)	<2	<2	<2	<2
Modulation Depth (extinction ratio)	>1,000,000:1 at 0 Hz, >250:1 at 150 MHz	>1,000,000:1 at 0 Hz, >250:1 at 150 MHz	>1,000,000:1 at 0 Hz, >250:1 at 150 MHz	>1,000,000:1 at 0 Hz, >250:1 at 150 MHz
Analog Modulation				
Maximum Bandwidth (kHz)	500	500	500	500
Rise Time (10% to 90%) (nsec)	<700	<700	<700	<700
Fall Time (90% to 10%) (nsec)	<700	<700	<700	<700
Modulation Depth (extinction ratio)	>1,000,000:1	>1,000,000:1	>1,000,000:1	>1,000,000:1
Static Alignment Tolerances				
Beam Position from Reference <sup>5</sup> (mm)	<1	<1	<1	<1
Beam Angle <sup>5</sup> (mrad)	<5	<5	<5	<5
Beam Waist Position at Exit Window (mm)	n/a	n/a	n/a	n/a
Laser Safety Classification	3b	3b	3b	3b
ESD Protection	EN61326-1	EN61326-1	EN61326-1	EN61326-1
Power Consumption (W)	Typical 5, Max. 13	Typical 5, Max. 13	Typical 5, Max. 13	Typical 5, Max. 13
Laser Head Baseplate Temp. (Max., °C)	50	50	50	50
Heat Dissipation of Laser Head <sup>6</sup> (W)	Typical 5, Max. 13	Typical 5, Max. 13	Typical 5, Max. 13	Typical 5, Max. 13
Ambient Temperature <sup>7</sup>				
Operating Condition <sup>8</sup> (°C)	10 to 50	10 to 50	10 to 50	10 to 50
Non-operating Condition (°C)	-20 to 60	-20 to 60	-20 to 60	-20 to 60
Shock Tolerance (g) (6 ms)	30	30	30	30

<sup>1</sup> Laser-to-laser wavelength tolerance ±2 nm for all OBIS LS versions. For OBIS LX wavelength tolerance of ±5 nm except for 413LX with a 410 nm to 420 nm range; 445LX at 365 mW with a 435 nm to 450 nm range; 458LX at 365 mW with a 450 nm to 465 nm range; 522LX with a 520 nm to 530 nm range; 633LX with a 629 nm to 636 nm range; 640LX with 635 nm to 644 nm range; 660LX with 652 nm to 665 nm range; and 685LX, 730LX, 750LX, 785LX, 808LX, and 980LX with a ±10 nm range.

<sup>2</sup> Output power is variable in CW Mode from 1 mW (1% for LX Models) to 110% of rated power. Specifications are valid for 100% power. For LS versions all residual laser emission at 808 nm pump/trigger or fundamental <0.1 mW.

<sup>3</sup> For LX versions the M<sup>2</sup> measured with ModeMaster with 90/10 clip levels.

<sup>4</sup> For LS versions typical power-on delay 1 minute. For LX versions typical power-on delay of 0.1 minutes.

<sup>5</sup> See mechanical drawing for exit beam location.

<sup>6</sup> Typically 85% of heat load through the base plate. See Users Manual for more detail.

<sup>7</sup> Non-Condensing. See User Manual for more detail.

<sup>8</sup> For LS versions laser head baseplate temperature needs to be maintained at ≤40°C.



UTILITY AND ENVIRONMENTAL REQUIREMENTS	
Operating Voltage <sup>1</sup> (VDC)	12 ±2
Dimensions (L x W x H)	
Laser	70 x 40 x 38 mm (2.75 x 1.57 x 1.5 in.)
OBIS Remote (optional)	105 x 68 x 36 mm (4.13 x 2.68 x 1.42 in.)
DC Power Supply (optional)	105 x 42 x 33 mm (4.13 x 1.65 x 1.3 in.)
Cable, Laser to OBIS Remote (optional)	1 m (3.28 ft.) (3 meter and 0.3 meter sold separately)
Weight	
Laser	0.16 kg (0.35 lbs.)
OBIS Remote (optional)	0.24 kg (0.53 lbs.)
DC Power Supply (optional)	0.36 kg (0.79 lbs.)
Cable, Laser to OBIS Remote (optional)	0.1 kg (0.22 lbs.) for 1 meter

<sup>1</sup> If user supplied, the DC power supply has to meet the following requirements: power >20W; ripple <5% peak-to-peak; line regulation <0.5%.

## MECHANICAL SPECIFICATIONS

### OBIS LX/LS

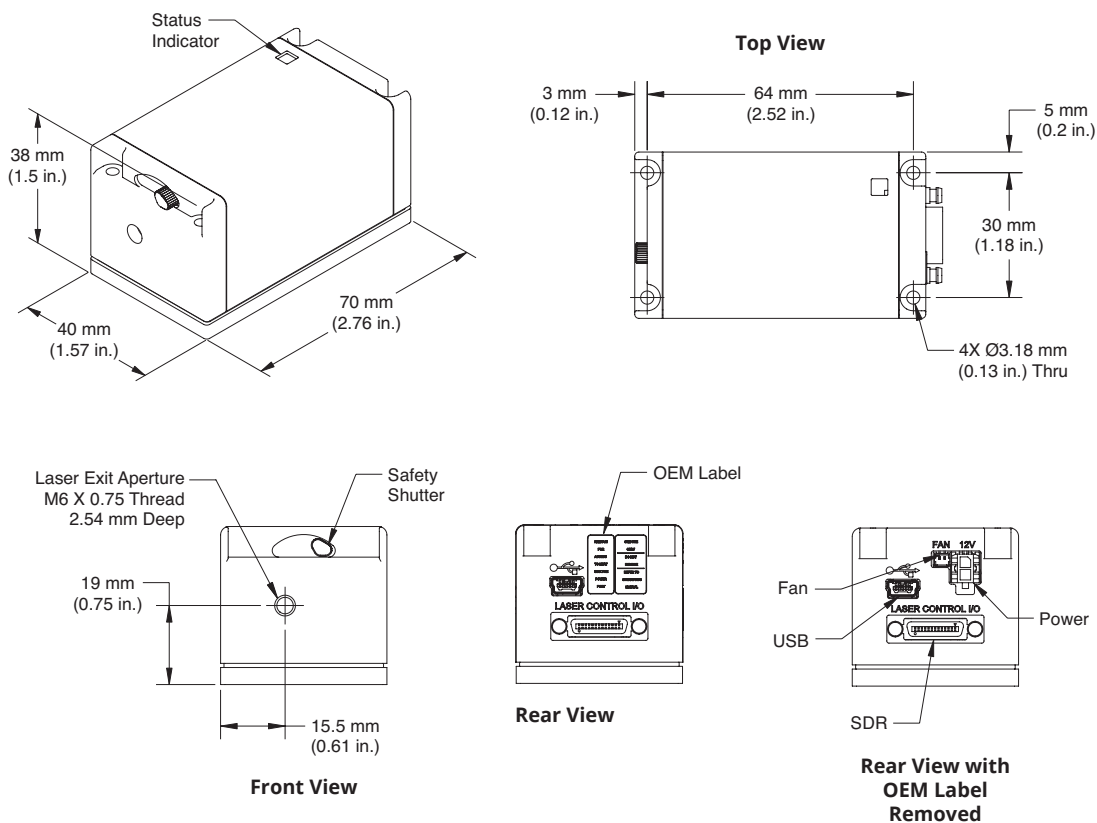

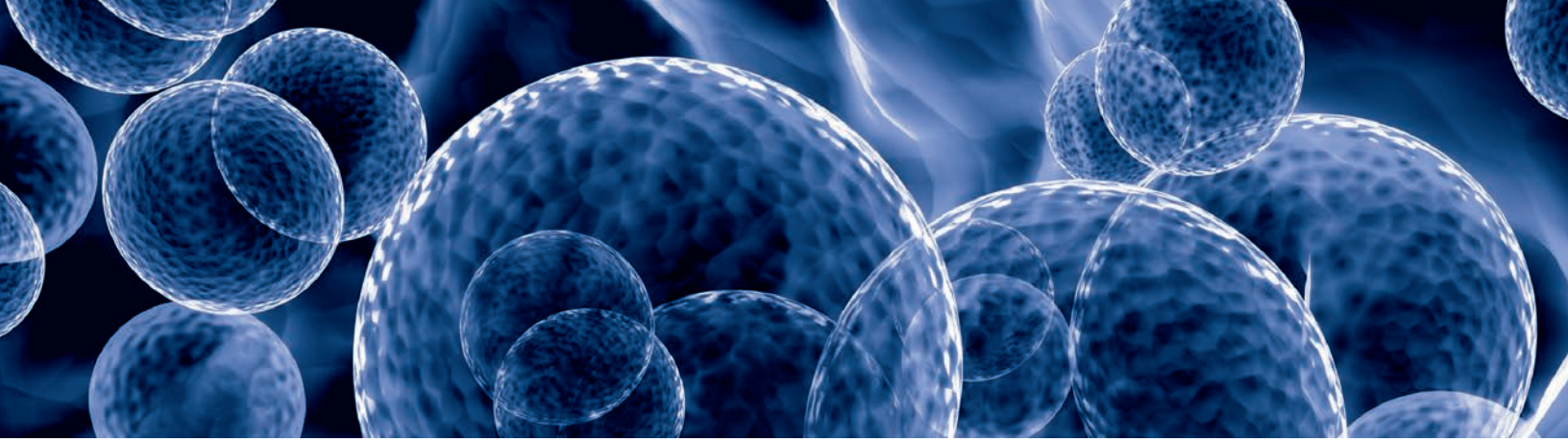

# OBIS LX/LS FP

## Fiber Pigtailed Lasers in a Plug-and-Play Platform

The OBIS LX/LS Fiber Pigtailed (OBIS FP) suite of lasers delivers the simplicity of a plug-and-play platform for a wide range of wavelengths from the violet to the near IR. The fiber pigtail termination is complete with a FC/APC connector. The OBIS LX/LS FP lasers are based on the OBIS LX/LS laser platform, offering the same speed-to-market benefits.

The OBIS LX/LS FP lasers offer superior performance, reliability, and hands-free operation. These lasers combine single-mode polarization maintaining fiber with an FC/APC connector for a high-quality low-noise laser beam output. They utilize proprietary fiber technology to provide superior lifetimes, and permanent fiber attachments for guaranteed power over time.

OBIS LX/LS FP lasers are also compatible with MetaMorph and  $\mu$ Manager Software for microscopy automation and image analysis.



### FEATURES & BENEFITS

- All OBIS advantages with fiber delivery
- Single mode, polarization maintaining fiber
- Extended life fiber design

### APPLICATIONS

- Confocal Microscopy
- DNA Sequencing
- Flow Cytometry
- Medical Imaging and Instrumentation

SPECIFICATIONS	OBIS FP 375LX	OBIS FP 405LX	OBIS FP 413LX	OBIS FP 445LX
Wavelength <sup>1</sup> (nm)	375	405	413	445
Output Power <sup>2</sup> (mW)	25	50, 100	50	45, 200
Output from Fiber	FC/APC; 8° angled <sup>8</sup>	FC/APC; 8° angled <sup>8</sup>	FC/APC; 8° angled <sup>8</sup>	FC/APC; 8° angled <sup>8</sup>
Fiber Cable Type	3 mm Mono-Coil	3 mm Mono-Coil	3 mm Mono-Coil	3 mm Mono-Coil
Fiber Cable Length (m) (minimum)	1	1 (optional 2 m)	1	1
Fiber Numerical Aperture (NA) (1/e <sup>2</sup> )	0.05	0.05	0.05	0.05
Fiber Core Diameter (μm) (typical)	3.5	3.5	3.5	3.5
Spatial Mode	TEM <sub>00</sub>	TEM <sub>00</sub>	TEM <sub>00</sub>	TEM <sub>00</sub>
M <sup>2</sup> (Beam Quality) <sup>3</sup>	≤1.1	≤1.1	≤1.1	≤1.1
Beam Asymmetry	≤1:1.1	≤1:1.1	≤1:1.1	≤1:1.1
RMS Noise (%) (20 Hz to 20 MHz)	≤0.2	≤0.2	≤0.2	≤0.2
Peak-to-Peak Noise (%) (20 Hz to 20 kHz)	≤2	≤2	≤2	≤2
Long-term Power Stability (%) (8 hrs., ±3°C)	<2	<2	<2	<2
Long-term Output Power Average (%/hrs.)	≤10/1000	≤5/1000	≤5/1000	≤5/1000
Warm-up Time <sup>4</sup> (minutes) (from cold start)	<5	<5	<5	<5
Polarization Ratio	Minimum 50:1	Minimum 100:1	Minimum 100:1	Minimum 100:1
Laser Drive Modes	CW, Analog Modulation, Digital Modulation and Computer Control			
Digital Modulation				
Maximum Bandwidth (MHz)	75	150	150	150
Rise Time (10% to 90%) (nsec)	<5	<2	<2	<2
Fall Time (90% to 10%) (nsec)	<5	<2	<2	<2
Modulation Depth (extinction ratio)	>1,000,000:1 at 0 Hz, >250:1 at 150 MHz	>1,000,000:1 at 0 Hz, >250:1 at 150 MHz	>1,000,000:1 at 0 Hz, >250:1 at 150 MHz	>1,000,000:1 at 0 Hz, >250:1 at 150 MHz
Analog Modulation				
Maximum Bandwidth (kHz)	500	500	500	500
Rise Time (10% to 90%) (nsec)	<700	<700	<700	<700
Fall Time (90% to 10%) (nsec)	<700	<700	<700	<700
Modulation Depth (extinction ratio)	>1,000,000:1	>1,000,000:1	>1,000,000:1	>1,000,000:1
Laser Safety Classification	3b	3b	3b	3b
ESD Protection	EN61326-1	EN61326-1	EN61326-1	EN61326-1
Power Consumption (W)	Typical 5, Max. 13	Typical 5, Max. 13	Typical 5, Max. 13	Typical 5, Max. 13
Laser Head Baseplate Temperature (Max., °C)	50	50	50	50
Heat Dissipation of Laser Head <sup>5</sup> (W)	Typical 5, Max. 13	Typical 5, Max. 13	Typical 5, Max. 13	Typical 5, Max. 13
Ambient Temperature <sup>6</sup>				
Operating Condition <sup>7</sup> (°C)	10 to 50	10 to 50	10 to 50	10 to 50
Non-operating Condition (°C)	-20 to 60	-20 to 60	-20 to 60	-20 to 60
Shock Tolerance (g) (6 ms)	30	30	30	30

<sup>1</sup> Laser-to-laser wavelength tolerance ±2 nm for all OBIS LS versions. For OBIS LX wavelength tolerance of ±5 nm except for 413LX with a 410 nm to 420 nm range; 445LX at 200 mW with a 435 nm to 450 nm range; 458LX at 200 mW with a 450 nm to 465 nm range; 522LX with a 520 nm to 530 nm range; 633LX with a 629 nm to 636 nm range; 640LX with 635 nm to 644 nm range; 660LX with 652 nm to 665 nm range; and 685LX, 730LX, 750LX, 785LX, 808LX, and 980LX with a ±10 nm range.

<sup>2</sup> Output power is variable in CW Mode from 1 mW (1% for LX Models) to 110% of rated power. Specifications are valid for 100% power.

<sup>3</sup> M<sup>2</sup> measured with ModeMaster with 90/10 clip levels.

<sup>4</sup> For LS versions typical power-on delay 1 minute. For LX versions typical power-on delay of 0.1 minutes.

<sup>5</sup> Typically 85% of heat load through the base plate. See Users Manual for more detail.

<sup>6</sup> Non-Condensing. See User Manual for more detail.

<sup>7</sup> For LS versions laser head baseplate temperature needs to be maintained at ≤40°C.

<sup>8</sup> Fiber FC/APC connector output not compatible for patchcord-to-patchcord connection.

SPECIFICATIONS	OBIS FP 458LX	OBIS FP 473LX	OBIS FP 488LX	OBIS FP 488LS
Wavelength <sup>1</sup> (nm)	458	473	488	488
Output Power <sup>2</sup> (mW)	200	50	30, 100	15 40, 60, 80, 120
Output from Fiber	FC/APC; 8° angled <sup>8</sup>	FC/APC; 8° angled <sup>8</sup>	FC/APC; 8° angled <sup>8</sup>	FC/APC; 8° angled <sup>8</sup> FC/APC; 8° angled <sup>8</sup>
Fiber Cable Type	3 mm Mono-Coil	3 mm Mono-Coil	3 mm Mono-Coil	5 mm Protective Tubing
Fiber Cable Length (m) (minimum)	1	1	1	0.94
Fiber Numerical Aperture (NA) (1/e <sup>2</sup> )	0.05	0.05	0.05	0.1 0.06
Fiber Core Diameter (µm) (typical)	3.5	3.5	3.5	4
Spatial Mode	TEM <sub>00</sub>	TEM <sub>00</sub>	TEM <sub>00</sub>	TEM <sub>00</sub>
M <sup>2</sup> (Beam Quality) <sup>3</sup>	≤1.1	≤1.1	≤1.1	≤1.1
Beam Asymmetry	≤1:1.1	≤1:1.1	≤1:1.1	≤1:1.1
RMS Noise (%) (20 Hz to 20 MHz)	≤0.2	≤0.2	≤0.2	≤0.25
Peak-to-Peak Noise (%) (20 Hz to 20 kHz)	≤2	≤2	≤2	≤1
Long-term Power Stability (%) (8 hrs., ±3°C)	<2	<2	<2	<2
Long-term Output Power Average (%/hrs.)	≤5/1000	≤4/1000	≤4/1000	-
Warm-up Time <sup>4</sup> (minutes) (from cold start)	<5	<5	<5	<5
Polarization Ratio	Minimum 100:1	Minimum 100:1	Minimum 100:1	Minimum 100:1
Laser Drive Modes	CW, Analog Modulation, Digital Modulation and Computer Control			
Digital Modulation				
Maximum Bandwidth (MHz)	150	150	150	0.05
Rise Time (10% to 90%) (nsec)	<2	<2	<2	<18,000
Fall Time (90% to 10%) (nsec)	<2	<2	<2	<2000
Modulation Depth (extinction ratio)	>1,000,000:1 at 0 Hz, >250:1 at 150 MHz	>1,000,000:1 at 0 Hz, >250:1 at 150 MHz	>1,000,000:1 at 0 Hz, >250:1 at 150 MHz	Infinite at 0 Hz to 50 kHz
Analog Modulation				
Maximum Bandwidth (kHz)	500	500	500	500
Rise Time (10% to 90%) (nsec)	<700	<700	<700	<700
Fall Time (90% to 10%) (nsec)	<700	<700	<700	<700
Modulation Depth (extinction ratio)	>1,000,000:1	>1,000,000:1	>1,000,000:1	>1,000,000:1
Laser Safety Classification	3b	3b	3b	3b
ESD Protection	EN61326-1	EN61326-1	EN61326-1	EN61326-1
Power Consumption (W)	Typical 5, Max. 13	Typical 5, Max. 13	Typical 5, Max. 13	Typical 5, Max. 13
Laser Head Baseplate Temperature (Max., °C)	50	50	50	50
Heat Dissipation of Laser Head <sup>5</sup> (W)	Typical 5, Max. 13	Typical 5, Max. 13	Typical 5, Max. 13	Typical 5, Max. 13
Ambient Temperature <sup>6</sup>				
Operating Condition <sup>7</sup> (°C)	10 to 50	10 to 50	10 to 50	10 to 50
Non-operating Condition (°C)	-20 to 60	-20 to 60	-20 to 60	-20 to 60
Shock Tolerance (g) (6 ms)	30	30	30	30

<sup>1</sup> Laser-to-laser wavelength tolerance ±2 nm for all OBIS LS versions. For OBIS LX wavelength tolerance of ±5 nm except for 413LX with a 410 nm to 420 nm range; 445LX at 200 mW with a 435 nm to 450 nm range; 458LX at 200 mW with a 450 nm to 465 nm range; 522LX with a 520 nm to 530 nm range; 633LX with a 629 nm to 636 nm range; 640LX with 635 nm to 644 nm range; 660LX with 652 nm to 665 nm range; and 685LX, 730LX, 750LX, 785LX, 808LX, and 980LX with a ±10 nm range.

<sup>2</sup> Output power is variable in CW Mode from 1 mW (1% for LX Models) to 110% of rated power. Specifications are valid for 100% power.

<sup>3</sup> M<sup>2</sup> measured with ModeMaster with 90/10 clip levels.

<sup>4</sup> For LS versions typical power-on delay 1 minute. For LX versions typical power-on delay of 0.1 minutes.

<sup>5</sup> Typically 85% of heat load through the base plate. See Users Manual for more detail.

<sup>6</sup> Non-Condensing. See User Manual for more detail.

<sup>7</sup> For LS versions laser head baseplate temperature needs to be maintained at ≤40°C.

<sup>8</sup> Fiber FC/APC connector output not compatible for patchcord-to-patchcord connection.

SPECIFICATIONS	OBIS FP 505LX	OBIS FP 514LX	OBIS FP 514LS	OBIS FP 522LX
Wavelength <sup>1</sup> (nm)	505	514	514	522
Output Power <sup>2</sup> (mW)	40	30	15	25
Output from Fiber	FC/APC; 8° angled <sup>8</sup>	FC/APC; 8° angled <sup>8</sup>	FC/APC; 8° angled	FC/APC; 8° angled <sup>8</sup>
Fiber Cable Type	3 mm Mono-Coil	3 mm Mono-Coil	5 mm Protective Tubing	3 mm Mono-Coil
Fiber Cable Length (m) (minimum)	1	1	0.94	1
Fiber Numerical Aperture (NA) (1/e <sup>2</sup> )	0.05	0.05	0.1	0.05
Fiber Core Diameter (µm) (typical)	3.5	4.5	4	4.5
Spatial Mode	TEM <sub>00</sub>	TEM <sub>00</sub>	TEM <sub>00</sub>	TEM <sub>00</sub>
M <sup>2</sup> (Beam Quality) <sup>3</sup>	≤1.1	≤1.1	≤1.1	≤1.1
Beam Asymmetry	≤1:1.1	≤1:1.1	≤1:1.1	≤1:1.1
RMS Noise (%) (20 Hz to 20 MHz)	≤0.2	≤0.25	≤0.2	≤0.25
Peak-to-Peak Noise (%) (20 Hz to 20 kHz)	≤2	≤2	≤1	≤2
Long-term Power Stability (%) (8 hrs., ±3°C)	<2	<2	<2	≤2
Long-term Output Power Average (%/hrs.)	≤4/1000	≤3/1000	-	≤3/1000
Warm-up Time <sup>4</sup> (minutes) (from cold start)	<5	<5	<5	<5
Polarization Ratio	Minimum 100:1	Minimum 100:1	Minimum 100:1	Minimum 100:1
Laser Drive Modes	CW, Analog Modulation, Digital Modulation and Computer Control			
Digital Modulation				
Maximum Bandwidth (MHz)	150	100	0.05	100
Rise Time (10% to 90%) (nsec)	<2	<3.5	<18,000	<3.5
Fall Time (90% to 10%) (nsec)	<2	<2	<2000	<2
Modulation Depth (extinction ratio)	>1,000,000:1 at 0 Hz, >250:1 at 150 MHz	>1,000,000:1 at 0 Hz, >250:1 at 100 MHz	Infinite at 0 Hz to 50 kHz	>1,000,000:1 at 0 Hz, >250:1 at 100 MHz
Analog Modulation				
Maximum Bandwidth (kHz)	500	500	100	500
Rise Time (10% to 90%) (nsec)	<700	<700	<3000	<700
Fall Time (90% to 10%) (nsec)	<700	<700	<3000	<700
Modulation Depth (extinction ratio)	>1,000,000:1	>1,000,000:1	>50:1	>1,000,000:1
Laser Safety Classification	3b	3b	3b	3b
ESD Protection	EN61326-1	EN61326-1	EN61326-1	EN61326-1
Power Consumption (W)	Typical 5, Max. 13	Typical 5, Max. 13	Typical 8, Max. 12	Typical 5, Max. 13
Laser Head Baseplate Temperature (Max., °C)	50	50	40	50
Heat Dissipation of Laser Head <sup>5</sup> (W)	Typical 5, Max. 13	Typical 5, Max. 13	Typical 8, Max. 12	Typical 5, Max. 13
Ambient Temperature <sup>6</sup>				
Operating Condition <sup>7</sup> (°C)	10 to 50	10 to 50	15 to 40	10 to 50
Non-operating Condition (°C)	-20 to 60	-20 to 60	-20 to 60	-20 to 60
Shock Tolerance (g) (6 ms)	30	30	30	30

<sup>1</sup> Laser-to-laser wavelength tolerance ±2 nm for all OBIS LS versions. For OBIS LX wavelength tolerance of ±5 nm except for 413LX with a 410 nm to 420 nm range; 445LX at 200 mW with a 435 nm to 450 nm range; 458LX at 200 mW with a 450 nm to 465 nm range; 522LX with a 520 nm to 530 nm range; 633LX with a 629 nm to 636 nm range; 640LX with 635 nm to 644 nm range; 660LX with 652 nm to 665 nm range; and 685LX, 730LX, 750LX, 785LX, 808LX, and 980LX with a ±10 nm range.

<sup>2</sup> Output power is variable in CW Mode from 1 mW (1% for LX Models) to 110% of rated power. Specifications are valid for 100% power.

<sup>3</sup> M<sup>2</sup> measured with ModeMaster with 90/10 clip levels.

<sup>4</sup> For LS versions typical power-on delay 1 minute. For LX versions typical power-on delay of 0.1 minutes.

<sup>5</sup> Typically 85% of heat load through the base plate. See Users Manual for more detail.

<sup>6</sup> Non-Condensing. See User Manual for more detail.

<sup>7</sup> For LS versions laser head baseplate temperature needs to be maintained at ≤40°C.

<sup>8</sup> Fiber FC/APC connector output not compatible for patchcord-to-patchcord connection.

SPECIFICATIONS	OBIS FP 532LS	OBIS FP 552LS	OBIS FP 561LS	OBIS FP 594LS
Wavelength <sup>1</sup> (nm)	532	552	561	594
Output Power <sup>2</sup> (mW)	20      40, 60, 80, 120	15      40, 60, 80, 120	40, 60, 80, 120	40
Output from Fiber	FC/APC; 8° angled <sup>8</sup>	FC/APC; 8° angled <sup>8</sup>	FC/APC; 8° angled <sup>8</sup>	FC/APC; 8° angled <sup>8</sup>
Fiber Cable Type	5 mm Protective Tubing	5 mm Protective Tubing	5 mm Protective Tubing	5 mm Protective Tubing
Fiber Cable Length (m) (minimum)	0.94	0.94	0.94	0.94
Fiber Numerical Aperture (NA) (1/e <sup>2</sup> )	0.1      0.06	0.1      0.06	0.06	0.06
Fiber Core Diameter (µm) (typical)	4	4	4	4
Spatial Mode	TEM <sub>00</sub>	TEM <sub>00</sub>	TEM <sub>00</sub>	TEM <sub>00</sub>
M <sup>2</sup> (Beam Quality) <sup>3</sup>	≤1.1	≤1.1	≤1.1	≤1.1
Beam Asymmetry	≤1:1.1	≤1:1.1	≤1:1.1	≤1:1.1
RMS Noise (%) (20 Hz to 20 MHz)	≤0.25	≤0.25	≤0.25	≤0.25
Peak-to-Peak Noise (%) (20 Hz to 20 kHz)	≤1	≤1	≤1	≤1
Long-term Power Stability (%) (8 hrs., ±3°C)	<2	<2	<2	≤2
Long-term Output Power Average (%/hrs.)	-	-	-	-
Warm-up Time <sup>4</sup> (minutes) (from cold start)	<5	<5	<5	<5
Polarization Ratio	Minimum 100:1	Minimum 100:1	Minimum 100:1	Minimum 100:1
Laser Drive Modes	CW, Analog Modulation, Digital Modulation and Computer Control			
Digital Modulation				
Maximum Bandwidth (MHz)	0.05	0.05	0.05	0.05
Rise Time (10% to 90%) (nsec)	<18,000	<18,000	<18,000	<18,000
Fall Time (90% to 10%) (nsec)	<2000	<2000	<2000	<2000
Modulation Depth (extinction ratio)	Infinite at 0 Hz to 50 kHz	Infinite at 0 Hz to 50 kHz	Infinite at 0 Hz to 50 kHz	Infinite at 0 Hz to 50 kHz
Analog Modulation				
Maximum Bandwidth (kHz)	100	100	100	100
Rise Time (10% to 90%) (nsec)	<3000	<3000	<3000	<3000
Fall Time (90% to 10%) (nsec)	<3000	<3000	<3000	<3000
Modulation Depth (extinction ratio)	>50:1	>50:1	>50:1	>50:1
Laser Safety Classification	3b	3b	3b	3b
ESD Protection	EN61326-1	EN61326-1	EN61326-1	EN61326-1
Power Consumption (W)	Typical 8, Max. 12	Typical 8, Max. 12	Typical 8, Max. 12	Typical 8, Max. 12
Laser Head Baseplate Temperature (Max., °C)	40	40	40	40
Heat Dissipation of Laser Head <sup>5</sup> (W)	Typical 8, Max. 12	Typical 8, Max. 12	Typical 8, Max. 12	Typical 8, Max. 12
Ambient Temperature <sup>6</sup>				
Operating Condition <sup>7</sup> (°C)	15 to 40	15 to 40	15 to 40	15 to 40
Non-operating Condition (°C)	-20 to 60	-20 to 60	-20 to 60	-20 to 60
Shock Tolerance (g) (6 ms)	30	30	30	30

<sup>1</sup> Laser-to-laser wavelength tolerance ±2 nm for all OBIS LS versions. For OBIS LX wavelength tolerance of ±5 nm except for 413LX with a 410 nm to 420 nm range; 445LX at 200 mW with a 435 nm to 450 nm range; 458LX at 200 mW with a 450 nm to 465 nm range; 522LX with a 520 nm to 530 nm range; 633LX with a 629 nm to 636 nm range; 640LX with 635 nm to 644 nm range; 660LX with 652 nm to 665 nm range; and 685LX, 730LX, 750LX, 785LX, 808LX, and 980LX with a ±10 nm range.

<sup>2</sup> Output power is variable in CW Mode from 1 mW (1% for LX Models) to 110% of rated power. Specifications are valid for 100% power.

<sup>3</sup> M<sup>2</sup> measured with ModeMaster with 90/10 clip levels.

<sup>4</sup> For LS versions typical power-on delay 1 minute. For LX versions typical power-on delay of 0.1 minutes.

<sup>5</sup> Typically 85% of heat load through the base plate. See Users Manual for more detail.

<sup>6</sup> Non-Condensing. See User Manual for more detail.

<sup>7</sup> For LS versions laser head baseplate temperature needs to be maintained at ≤40°C.

<sup>8</sup> Fiber FC/APC connector output not compatible for patchcord-to-patchcord connection.

SPECIFICATIONS	OBIS FP 633LX	OBIS FP 637LX	OBIS FP 640LX
Wavelength <sup>1</sup> (nm)	633	637	640
Output Power <sup>2</sup> (mW)	50	100, 120	75
Output from Fiber	FC/APC; 8° angled	FC/APC; 8° angled	FC/APC; 8° angled
Fiber Cable Type	3 mm Mono-Coil	3 mm Mono-Coil	3 mm Mono-Coil
Fiber Cable Length (m) (minimum)	1	1	1
Fiber Numerical Aperture (NA) (1/e <sup>2</sup> )	0.09	0.09	0.09
Fiber Core Diameter (μm) (typical)	4.5	4.5	4.5
Spatial Mode	TEM <sub>00</sub>	TEM <sub>00</sub>	TEM <sub>00</sub>
M <sup>2</sup> (Beam Quality) <sup>3</sup>	≤1.1	≤1.1	≤1.1
Beam Asymmetry	≤1:1.1	≤1:1.1	≤1:1.1
RMS Noise (%) (20 Hz to 20 MHz)	≤0.2	≤0.2	≤0.2
Peak-to-Peak Noise (%) (20 Hz to 20 kHz)	≤2	≤2	≤2
Long-term Power Stability (%) (8 hrs., ±3°C)	<2	<2	<2
Long-term Output Power Average (%/hrs.)	≤3/1000	≤3/1000	≤3/1000
Warm-up Time <sup>4</sup> (minutes) (from cold start)	<5	<5	<5
Polarization Ratio	Minimum 100:1	Minimum 100:1	Minimum 100:1
Laser Drive Modes	CW, Analog Modulation, Digital Modulation and Computer Control		
Digital Modulation			
Maximum Bandwidth (MHz)	150	150	150
Rise Time (10% to 90%) (nsec)	<2	<2	<2
Fall Time (90% to 10%) (nsec)	<2	<2	<2
Modulation Depth (extinction ratio)	>1,000,000:1 at 0 Hz, >250:1 at 150 MHz	>1,000,000:1 at 0 Hz, >250:1 at 150 MHz	>1,000,000:1 at 0 Hz, >250:1 at 150 MHz
Analog Modulation			
Maximum Bandwidth (kHz)	500	300	500
Rise Time (10% to 90%) (nsec)	<700	<1200	<700
Fall Time (90% to 10%) (nsec)	<700	<800	<700
Modulation Depth (extinction ratio)	>1,000,000:1	>1,000,000:1	>1,000,000:1
Laser Safety Classification	3b	3b	3b
ESD Protection	EN61326-1	EN61326-1	EN61326-1
Power Consumption (W)	Typical 5, Max. 13	Typical 5, Max. 13	Typical 5, Max. 13
Laser Head Baseplate Temperature (Max., °C)	50	50	50
Heat Dissipation of Laser Head <sup>5</sup> (W)	Typical 5, Max. 13	Typical 5, Max. 13	Typical 5, Max. 13
Ambient Temperature <sup>6</sup>			
Operating Condition <sup>7</sup> (°C)	10 to 50	10 to 50	10 to 50
Non-operating Condition (°C)	-20 to 60	-20 to 60	-20 to 60
Shock Tolerance (g) (6 ms)	30	30	30

<sup>1</sup> Laser-to-laser wavelength tolerance ±2 nm for all OBIS LS versions. For OBIS LX wavelength tolerance of ±5 nm except for 413LX with a 410 nm to 420 nm range; 445LX at 200 mW with a 435 nm to 450 nm range; 458LX at 200 mW with a 450 nm to 465 nm range; 522LX with a 520 nm to 530 nm range; 633LX with a 629 nm to 636 nm range; 640LX with 635 nm to 644 nm range; 660LX with 652 nm to 665 nm range; and 685LX, 730LX, 750LX, 785LX, 808LX, and 980LX with a ±10 nm range.

<sup>2</sup> Output power is variable in CW Mode from 1 mW (1% for LX Models) to 110% of rated power. Specifications are valid for 100% power.

<sup>3</sup> M<sup>2</sup> measured with ModeMaster with 90/10 clip levels.

<sup>4</sup> For LS versions typical power-on delay 1 minute. For LX versions typical power-on delay of 0.1 minutes.

<sup>5</sup> Typically 85% of heat load through the base plate. See Users Manual for more detail.

<sup>6</sup> Non-Condensing. See User Manual for more detail.

<sup>7</sup> For LS versions laser head baseplate temperature needs to be maintained at ≤40°C.



SPECIFICATIONS	OBIS FP 647LX	OBIS FP 660LX	OBIS FP 785LX
Wavelength <sup>1</sup> (nm)	647	660	785
Output Power <sup>2</sup> (mW)	100	75	70
Output from Fiber	FC/APC; 8° angled	FC/APC; 8° angled	FC/APC; 8° angled
Fiber Cable Type	3 mm Mono-Coil	3 mm Mono-Coil	3 mm Mono-Coil
Fiber Cable Length (m) (minimum)	1	1	1
Fiber Numerical Aperture (NA) (1/e <sup>2</sup> )	0.09	0.09	0.12
Fiber Core Diameter (μm) (typical)	4.5	4.5	4.5
Spatial Mode	TEM <sub>00</sub>	TEM <sub>00</sub>	TEM <sub>00</sub>
M <sup>2</sup> (Beam Quality) <sup>3</sup>	≤1.1	≤1.1	≤1.1
Beam Asymmetry	≤1:1.1	≤1:1.1	≤1:1.1
RMS Noise (%) (20 Hz to 20 MHz)	≤0.2	≤0.2	≤0.2
Peak-to-Peak Noise (%) (20 Hz to 20 kHz)	≤2	≤2	≤2
Long-term Power Stability (%) (8 hrs., ±3°C)	<2	≤2	≤2
Long-term Output Power Average (%/hrs.)	≤3/1000	≤3/1000	≤3/1000
Warm-up Time <sup>4</sup> (minutes) (from cold start)	<5	<5	<5
Polarization Ratio	Minimum 100:1	Minimum 100:1	Minimum 100:1
Laser Drive Modes			
Digital Modulation			
Maximum Bandwidth (MHz)	150	150	150
Rise Time (10% to 90%) (nsec)	<2	<2	<2
Fall Time (90% to 10%) (nsec)	<2	<2	<2
Modulation Depth (extinction ratio)	>1,000,000:1 at 0 Hz, >250:1 at 150 MHz	>1,000,000:1 at 0 Hz, >250:1 at 150 MHz	>1,000,000:1 at 0 Hz, >250:1 at 150 MHz
Analog Modulation			
Maximum Bandwidth (kHz)	500	500	500
Rise Time (10% to 90%) (nsec)	<700	<700	<700
Fall Time (90% to 10%) (nsec)	<700	<700	<700
Modulation Depth (extinction ratio)	>1,000,000:1	>1,000,000:1	>1,000,000:1
Laser Safety Classification	3b	3b	3b
ESD Protection	EN61326-1	EN61326-1	EN61326-1
Power Consumption (W)	Typical 5, Max. 13	Typical 5, Max. 13	Typical 5, Max. 13
Laser Head Baseplate Temperature (Max., °C)	50	50	50
Heat Dissipation of Laser Head <sup>5</sup> (W)	Typical 5, Max. 13	Typical 5, Max. 13	Typical 5, Max. 13
Ambient Temperature <sup>6</sup>			
Operating Condition <sup>7</sup> (°C)	10 to 50	10 to 50	10 to 50
Non-operating Condition (°C)	-20 to 60	-20 to 60	-20 to 60
Shock Tolerance (g) (6 ms)	30	30	30

<sup>1</sup> Laser-to-laser wavelength tolerance ±2 nm for all OBIS LS versions. For OBIS LX wavelength tolerance of ±5 nm except for 413LX with a 410 nm to 420 nm range; 445LX at 200 mW with a 435 nm to 450 nm range; 458LX at 200 mW with a 450 nm to 465 nm range; 522LX with a 520 nm to 530 nm range; 633LX with a 629 nm to 636 nm range; 640LX with 635 nm to 644 nm range; 660LX with 652 nm to 665 nm range; and 685LX, 730LX, 750LX, 785LX, 808LX, and 980LX with a ±10 nm range.

<sup>2</sup> Output power is variable in CW Mode from 1 mW (1% for LX Models) to 110% of rated power. Specifications are valid for 100% power.

<sup>3</sup> M<sup>2</sup> measured with ModeMaster with 90/10 clip levels.

<sup>4</sup> For LS versions typical power-on delay 1 minute. For LX versions typical power-on delay of 0.1 minutes.

<sup>5</sup> Typically 85% of heat load through the base plate. See Users Manual for more detail.

<sup>6</sup> Non-Condensing. See User Manual for more detail.

<sup>7</sup> For LS versions laser head baseplate temperature needs to be maintained at ≤40°C.

UTILITY AND ENVIRONMENTAL REQUIREMENTS	
Operating Voltage <sup>1</sup> (VDC)	12 ±2
Dimensions (L x W x H)	
Laser	70 x 40 x 38 mm (2.75 x 1.57 x 1.5 in.)
OBIS Remote (optional)	105 x 68 x 36 mm (4.13 x 2.68 x 1.42 in.)
DC Power Supply (optional)	105 x 42 x 33 mm (4.13 x 1.65 x 1.3 in.)
Cable, Laser to OBIS Remote (optional)	1 m (3.28 ft.) (3 meter and 0.3 meter sold separately)
Fiber Minimum Bend Radius	51 mm (2.0 in.)
Weight	
Laser	0.23 kg (0.5 lbs.)
OBIS Remote (optional)	0.23 kg (0.5 lbs.)
DC Power Supply (optional)	0.36 kg (0.79 lbs.)
Cable, Laser to OBIS Remote (optional)	0.1 kg (0.22 lbs.) for 1 meter
Fiber Tensile Load (max.)	1 kg (2.2 lbs.)

<sup>1</sup> If user supplied, the DC power supply has to meet the following requirements: power >20W; ripple <5% peak-to-peak; line regulation <0.5%.

## MECHANICAL SPECIFICATIONS

### OBIS LX FP

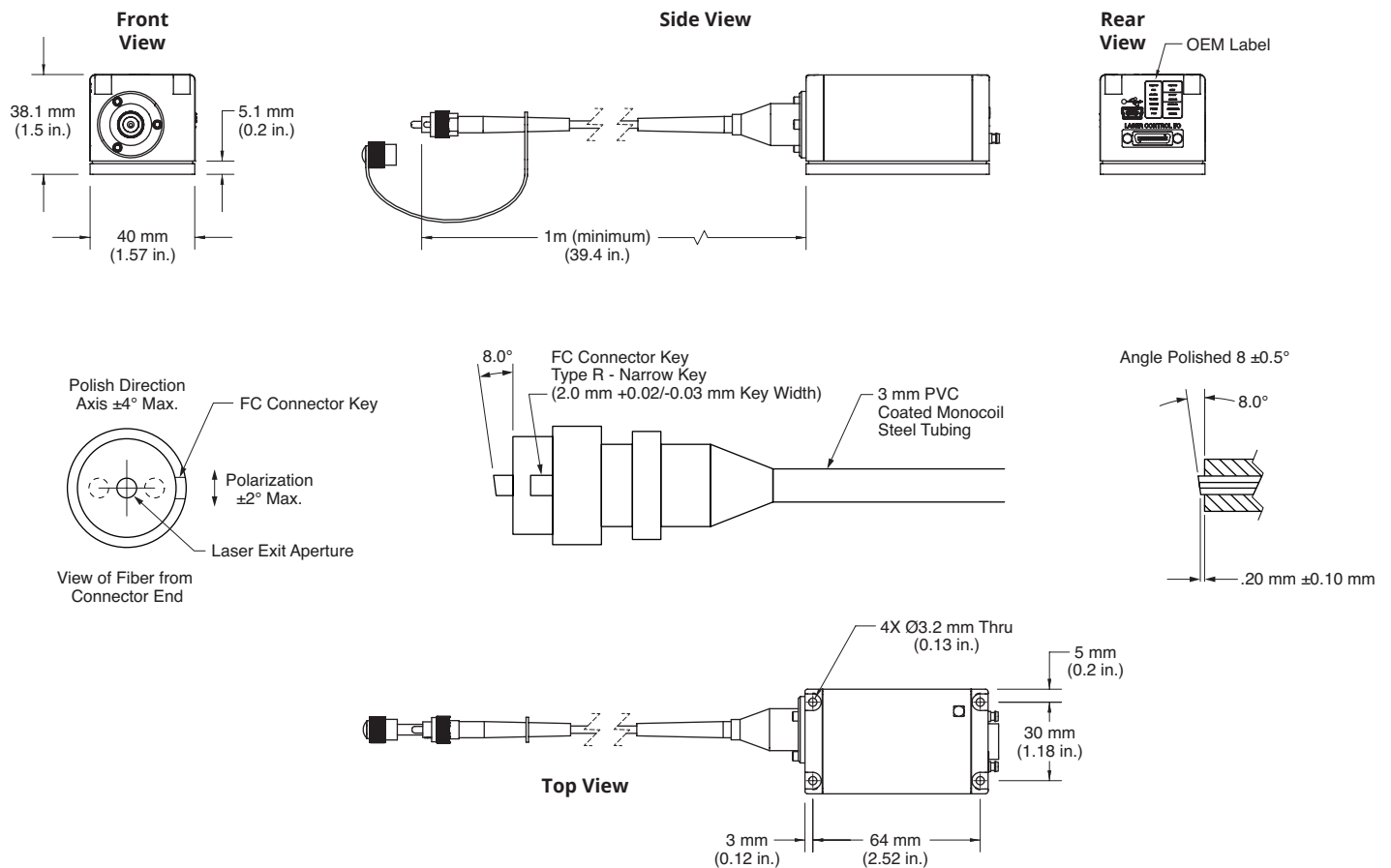

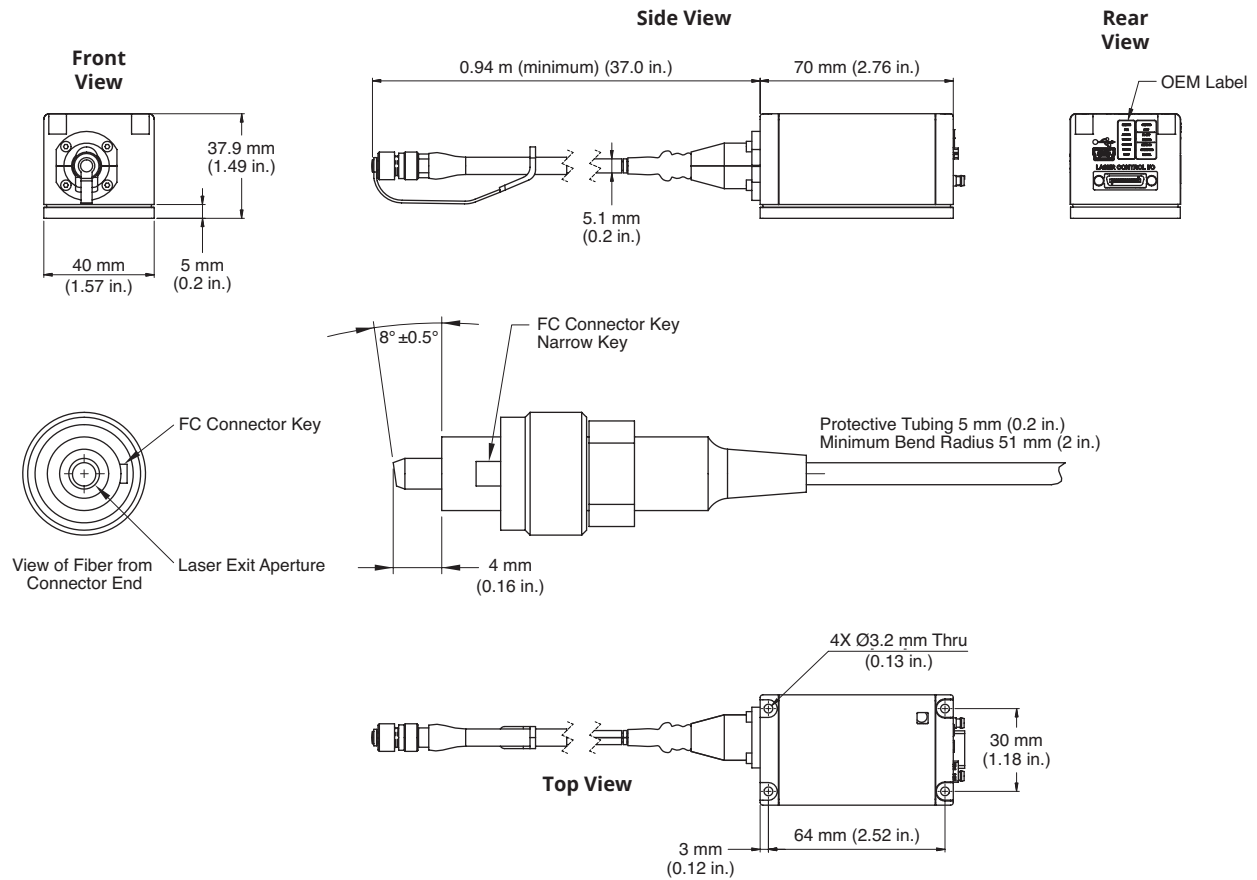

**MECHANICAL SPECIFICATIONS**

**OBIS LS FP**



**Looking for OBIS Galaxy Lasers? Please refer to the OBIS Galaxy data sheet and/or web page.**

Optional OBIS Laser Accessories	Description
	<p>OBIS Heat Sink with fan for thermal management, includes hardware to mount to table. Laser can be mounted on top or side for horizontal polarization. Convenient 69 mm (2.7 inch) beam height.</p> <p>Part Number 1193289 OBIS Heat Sink Mount.</p>
	<p>OBIS LX/LS Single Laser Remote with full features for control with Analog and Digital modulation inputs. Includes USB and RS-232 connectors on the back panel of the Remote.</p> <p>Part Number 1214875 OBIS LX/LS Single Laser Remote, with Power Supply, 1 meter laser-to-remote (SDR) cable, USB cable, and Coherent Connection applications software.</p> <p>Part Number 1173961 OBIS LX/LS Single Laser Remote, with Power Supply, USB cable, and Coherent Connection applications software (no SDR Laser-to-Remote cable).</p>
	<p>OBIS LX/LS 6-Laser Remote with CDRH features. Separate power switches and power cables for each laser. NOTE: Does not support modulation inputs.</p> <p>Part Number 1203909 OBIS LX/LS 6-Laser Remote, with Power Supply, 6 power cables from laser-to-remote, and Coherent Connection applications software.</p> <p>Part Number 1306263 OBIS LX/LS 6-Laser Remote, with Power Supply and Coherent Connection applications software (no laser-to-remote power cables).</p>
	<p>OBIS LX/LS Scientific Remote with full features for control with analog/digital inputs for up to six lasers. User interface touch screen and connectivity through USB, RS-232, and Ethernet.</p> <p>Part Number 1234466 OBIS LX/LS Scientific Remote, with internal Power Supply, 6 laser-to-remote (SDR) cables, and Coherent Connection applications software.</p> <p>Part Number 1234465 OBIS LX/LS Scientific Remote, with internal Power Supply, and Coherent Connection applications software (no SDR Laser-to-Remote cables).</p>
	<p>OBIS LX/LS Laser Box with five laser mounting bays with thermal management, cooling fans, analog/digital inputs, RS-232, USB, key-switch, and interlock in one compact package. Lasers sold separately.</p> <p>Part Number 1228877 OBIS LX/LS Laser Box, with Power Supply, USB cable, and Coherent Connection applications software. Analog Modulation Impedance = 2k <math>\Omega</math>, Digital Modulation Impedance = 50 <math>\Omega</math>.</p> <p>Part Number 1343229 OBIS LX/LS Laser Box, with Power Supply, USB cable, and Coherent Connection applications software. Analog Modulation Impedance = 2k <math>\Omega</math>, Digital Modulation Impedance = 2k <math>\Omega</math>.</p>



Coherent, Inc.,  
 5100 Patrick Henry Drive Santa Clara, CA 95054  
 p. (800) 527-3786 | (408) 764-4983  
 f. (408) 764-4646

[tech.sales@coherent.com](mailto:tech.sales@coherent.com) [www.coherent.com](http://www.coherent.com)



Coherent follows a policy of continuous product improvement. Specifications are subject to change without notice. Coherent's scientific and industrial lasers are certified to comply with the Federal Regulations (21 CFR Subchapter J) as administered by the Center for Devices and Radiological Health on all systems ordered for shipment after August 2, 1976.

Coherent offers a limited warranty for all OBIS LX/LS Lasers. For full details of this warranty coverage, please refer to the Service section at [www.coherent.com](http://www.coherent.com) or contact your local Sales or Service Representative.  
 MC-008-12-0M0920Rev.Q Copyright ©2020 Coherent, Inc.

