



LEAP

High Energy, High Precision Processing

LEAP excimer lasers deliver a unique combination of high duty-cycle output, outstanding reliability, and low cost-of-ownership. This makes them an ideal source for a diverse assortment of demanding, high throughput, high-precision microprocessing tasks, ranging from display fabrication to reel-to-reel manufacturing of superconductive tape. LEAP lasers are available at wavelengths of either 248 nm or 308 nm, with output powers of up to 300 W (and pulse energies of up to 1 J). This power comes in a compact footprint package which is easily integrated into tools, or with other production equipment.

FEATURES & BENEFITS

- Compact industrial design for easy integration
- Pulse-on-Demand to enable cost effective Laser-Lift-Off
- High laser energy for fast and large area processing
- Ethernet interface for control and fast data acquisition
- 248 nm and 308 nm wavelengths for optimized processing of a large variety of materials

APPLICATIONS

- LLO – Laser Lift-Off
- PLD – Pulsed Laser Deposition
- LDP – Laser Direct Patterning
- Micro-Structuring
- LIFT – Laser Induced Forward Transfer



SPECIFICATIONS	LEAP 80K		LEAP 130K		LEAP 100K		LEAP 150K		LEAP 300K	
	80K	130K	80C	130C	100K	150K	100C	150C	300C	300K
Wavelength (nm)	248		308		248		308		308	248
Stabilized Energy Range (mJ)	550 to 650		550 to 650		900 to 1000 ¹		900 to 1000		900 to 1000	
Max. Stabilized Average Power (W)	81.25	130	81.25	130	100	150	100	150	300	
Max. Repetition Rate (Hz)	125	200	125	200	100	150	100	150	300	
Energy Stability (1 Sigma)	≤1.2		≤1.2		≤1.2		≤1.2		≤1.2	
Pulse Duration (FWHM) (ns)	29 ±5		22 ±5		32 ±5		27 ±5		29 ±5	32 ±5
Beam Dimensions (V x H, FWHM) (mm ²)	32 ±3.5 x 13 ±4		33 ±3.5 x 13 ±4		32 ±3.5 x 13 ±4		33 ±3.5 x 13 ±4		37 ±3.5 x 13 ±3	32 ±3.5 x 15 ±4
Divergence (V x H, FWHM) (mrad ²)	≤4.5 x ≤1.5		≤4.5 x ≤1.5		≤4.5 x ≤1.5		≤4.5 x ≤1.5		≤4.5 x ≤1.5	
Dynamic Gas Lifetime (at max. stabilized energy) (mio. pulses)	30		30		30		30		50	40
Electrical (kVA)	8.6 3-phase, 200/208 or 400 VAC, 50/60 Hz				9.6 3-phase, 200/208 or 400 VAC, 50/60 Hz				17 3-Phase 400 VAC 50/60 Hz,	
Water Cooling	20 l/min; T=19-21°C								0-40 l/min; T=11-15°C	
Weight	860 kg (1896 lbs.)								1100 kg (2425 lbs)	
Cabinet Size (L x W x H)	2415 x 800 x (1090 ±10) mm ³ 95.1 x 31.4 x (42.9 ±0.4) in. ³								2563 x 820 x (1125 ±10) mm ³ 100.9 x 32.3 x (45.1 ±0.4) in. ³	

¹ Max. pulse energy 1100 mJ at 10 Hz.

**LEAP 150K 1 Joule at 150 Hz,
Dynamic Energy Range (typical data)**

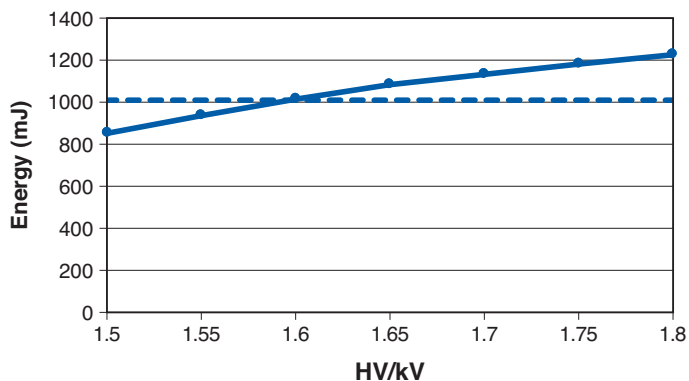

**LEAP 150K 1 Joule at 150 Hz,
Energy Stability over 30 Mio. Pulses**

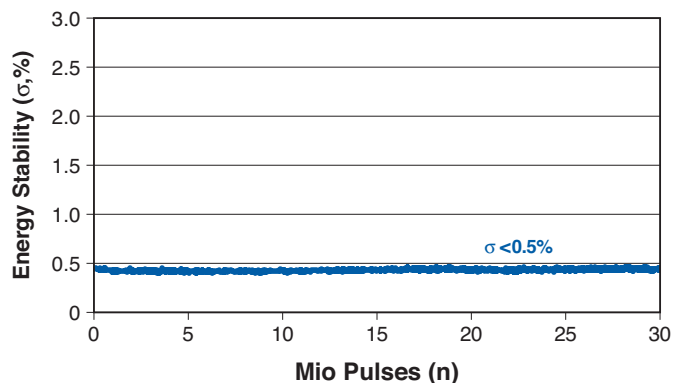

MECHANICAL SPECIFICATIONS

**LEAP 80/100/130/150 Beam Exit Left
(view from access side)**

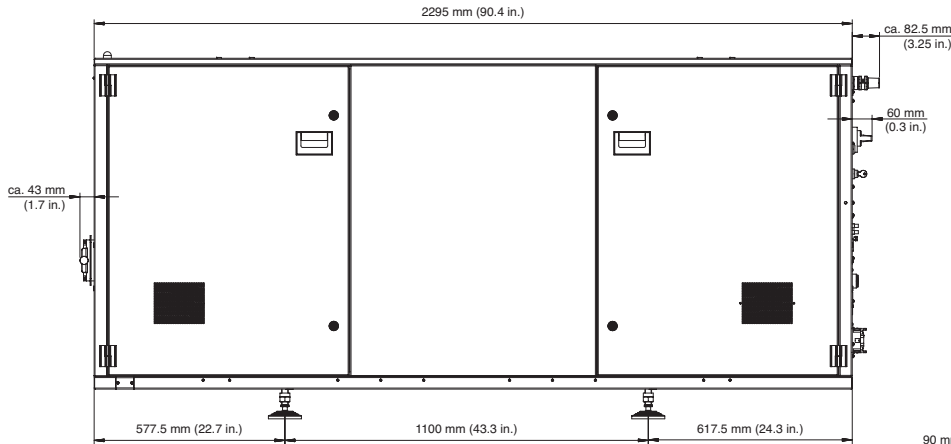

Front View

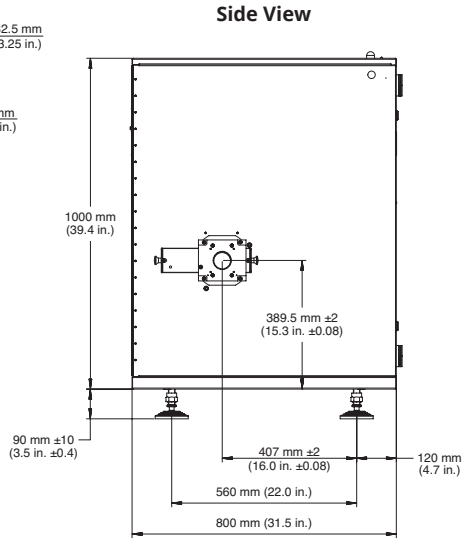

Side View

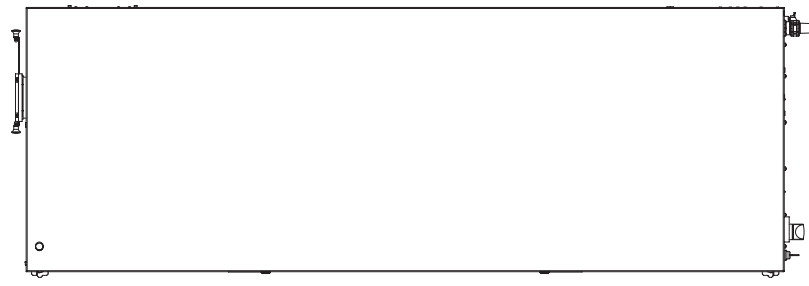

Top View

MECHANICAL SPECIFICATIONS

**LEAP 300C/300K Beam Exit Right
(view from access side)**

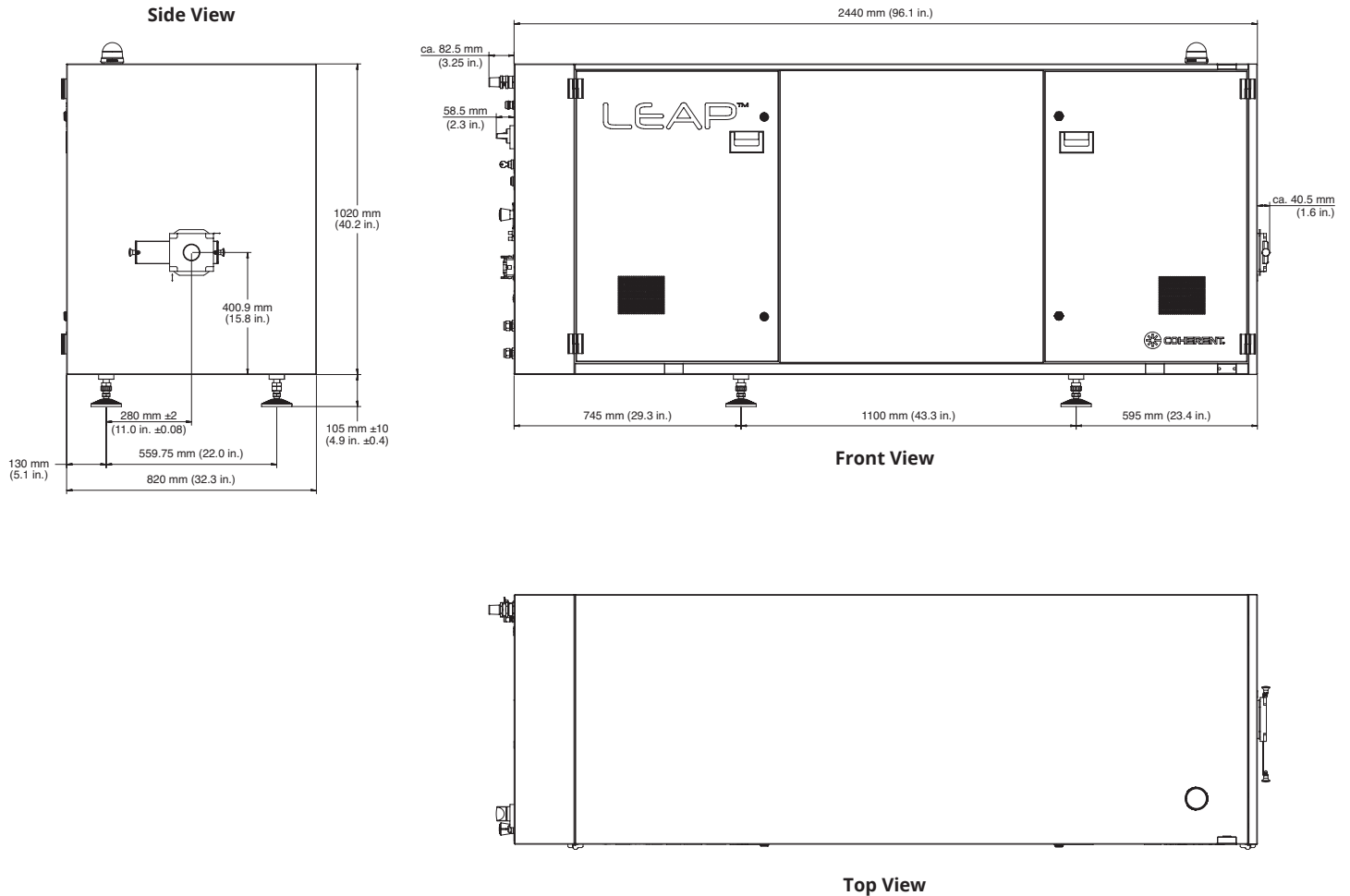

Coherent, Inc.,
 5100 Patrick Henry Drive Santa Clara, CA 95054
 p. (800) 527-3786 | (408) 764-4983
 f. (408) 764-4646

tech.sales@coherent.com www.coherent.com

Coherent follows a policy of continuous product improvement. Specifications are subject to change without notice. Coherent's scientific and industrial lasers are certified to comply with the Federal Regulations (21 CFR Subchapter J) as administered by the Center for Devices and Radiological Health on all systems ordered for shipment after August 2, 1976.

Coherent offers a limited warranty for all LEAP Lasers. For full details of this warranty coverage, please refer to the Service section at www.coherent.com or contact your local Sales or Service Representative. MC-021-15-0M0619Rev.C Copyright ©2019 Coherent, Inc.





VISIBLE AND INVISIBLE LASER RADIATION.
 AVOID EYE OR SKIN EXPOSURE TO
 DIRECT OR SCATTERED RADIATION.
 CLASS IV LASER RADIATION PRODUCT
 PER EN/IEC 60825-1 (2014)

MAX. OUTPUT POWER: 450 W
 MAX. OUTPUT ENERGY: 1.5 J/pulse
 PULSE DURATION: 10 to 50 ns
 WAVELENGTH: 193 to 351 nm